

## More light where it is needed.



### High luminous efficacy as a matter of principle.

High-intensity discharge lamps operate on the basis of the arc discharge. There is a constant arc between two electrodes that causes the filling to give light. This principle can be used with different metals and filler materials. Our range includes metal halide lamps, sodium lamps and mercury vapor lamps. Almost all discharge lamps need control gear to ignite them and limit their current.

### Metal halide lamps.

The addition of metals and iodides greatly improves the color and luminous efficacy of POWERSTAR® HQI® lamps. With their extremely short discharge arc, they come very close to the ideal of a point light source, which means their light is very easy to direct exactly where it is needed, and they offer a high utilization factor. POWERBALL® HCl® lamps represent a further development of POWERSTAR® HQI® metal halide lamps, our most successful metal halide lamps. They are fully compatible with the corresponding HQI® lamps. Their constant color throughout their lives, their luminous efficacy and their color rendering are all excellent. With its round ceramic discharge vessel, patented by OSRAM, it provides even better performance than its cylindrical counterparts in terms of light, color and stability.

### Optimum operation with electronic control gear.

The system reliability, comfort and economy of 20, 35, 70 and 150 W HQI®/HCl® lamps are considerably improved if the lamps are operated with POWERTRONIC® ECG.

### VIALOX® NAV® high-pressure sodium lamps.

VIALOX® high-pressure sodium lamps provide the highest luminous efficacy of all high-pressure discharge lamps – up to 150 lumens per watt.

#### Their principal benefits are as follows:

- Extremely high luminous efficacy
- Extremely long life

They are the most economical light sources in general lighting that enable the human eye to distinguish between colors. OSRAM has developed a large range of high-pressure sodium lamps. They are available in three complete VIALOX® NAV® families:

- NAV® with high reliability and economy
- NAV® 4Y® with highest reliability and economy
- NAV® SUPER 4Y® with outstanding luminous efficacy and highest reliability

NAV® 4Y® – technology that takes us into the third millennium. With the new OSRAM VIALOX® NAV® 4Y® lamps it is possible to prolong the period between group exchanges of high-pressure sodium lamps in street lighting to four years. Innovative arc tube design, high-performance ceramics, shock absorbers and the most up-to-date manufacturing processes such as laser welding are all combined to produce virtually perfect arc tubes every time. Longer maintenance intervals and a reduction in premature failures add up to considerable savings in relamping costs. The best performance is achieved by VIALOX® NAV® SUPER 4Y® lamps. The luminous flux of the lamp is up to 20% higher than that of conventional high-pressure sodium lamps. New and upgraded lighting systems can be operated most economically with VIALOX® NAV® SUPER 4Y® lamps.

### HQL® mercury vapor lamps.

HQL® mercury vapor lamps are often used as light sources because of the low investment costs. They need a control gear but not an igniter. Because of their low efficiency, mercury vapor lamps consume much more electrical energy than, for example, metal halide lamps or high-pressure sodium lamps. High-pressure mercury vapor lamps are used primarily for street and factory lighting.



**Metal halide lamps with ceramic technology**  
**POWERBALL® HCI®-T for enclosed luminaires**  
**POWERBALL® HCI®-TM for enclosed luminaires**

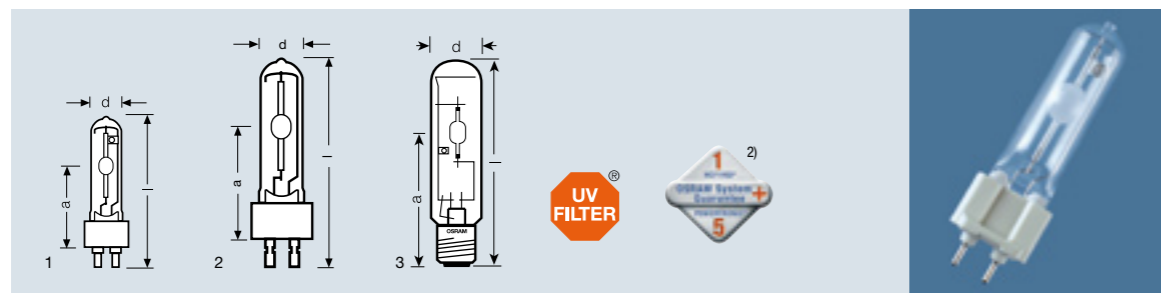

Product reference	Product number	W	lm		d max. [mm]	l max. [mm]	LCL a [mm]		No.	
<b>POWERBALL® HCI®-T for enclosed luminaires</b>										
HCI-T 35/830 WDL PB	4008321005625	35	3600	G12	19	100	56	12	1	
HCI-T 35/942 ND L PB	4050300873480	35	3500	G12	19	100	56	12	1	
HCI-T 70/830 WDL PB	4050300873664	70	7300	G12	19	100	56	12	1	
HCI-T 70/942 ND L PB	4050300873626	70	6800	G12	19	100	56	12	1	
HCI-T 100/830 WDL PB <sup>1)</sup>	4008321907660	100	9500	G12	19	105	56	12	1	
HCI-T 100/942 ND L PB <sup>1)</sup>	4008321907677	100	9300	G12	19	105	56	12	1	
HCI-T 150/830 WDL PB	4050300873435	150	15000	G12	25	105	56	12	1	
HCI-T 150/942 ND L PB	4050300873336	150	14500	G12	25	105	56	12	1	
E40 base										
HCI-T 250/830 WDL PB <sup>3)</sup>	4050300636849	250	26000	E40	46	226	150	12	3	
HCI-T 250/942 ND L PB <sup>1)3)</sup>	4008321908308	250	25000	E40	46	226	150	12	3	
<b>POWERBALL® HCI®-TM for enclosed luminaires</b>										
HCI-TM 250/830 WDL PB <sup>3)</sup>	4050300977263	250	26000	G22	34	175	90	10	2	
HCI-TM 250/942 ND L PB <sup>3)</sup>	4008321907684	250	25000	G22	34	175	90	10	2	
HCI-TM 400/942 ND L PB <sup>1)3)</sup>	4008321907691	400	40000	G22	34	175	90	10	2	

**All HCI® lamps feature innovative POWERBALL® technology.**

POWERBALL® HCI®-T lamps are single-ended UV-reduced lamps. Approved for use only in enclosed luminaires.

**Benefits of POWERBALL® technology:**

- High luminous flux
- Best distribution of light
- Best color rendering
- Longest color constancy
- Small loss of luminous flux over lifetime
- Little dependency on burning position
- Full output available soon after switching the lamp on
- Lower failure rate due to ceramic corrosion

**Benefits of UV FILTER technology**

- Reduced brittleness of the plastics in luminaires
- The UV filter on the lamp meets the requirements of IEC 61167

**New**

- **HCI®-T 100 W** closes the gap between 70 W and 150 W
- **HCI®-TM 250 W and 400 W** are much more compact than other discharge lamps of the same output. For all applications in which light is focused. G22 plug-in base for good positioning. Ideal for light guide systems and spotlight systems. Approved for hot restart up to 25 kV.

**Applications**

- Retail outlets and shop windows
- High-quality presentation of merchandise
- Museums, foyers and art galleries
- Outdoor lighting

1) In preparation  
 2) For HCI-T 35, 70, 150 W  
 3) Operate with NAV® control gear

**Metal halide lamps with ceramic technology**  
**POWERBALL® HCI®-TC for enclosed luminaires**

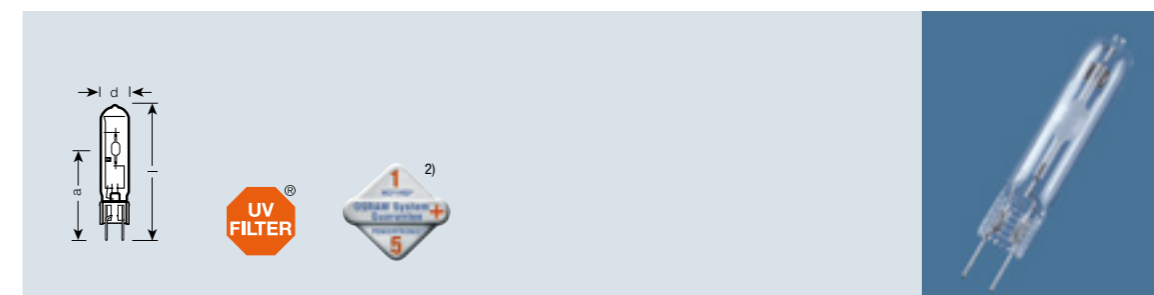

Product reference	Product number	W	lm		d max. [mm]	l max. [mm]	LCL a [mm]		
<b>POWERBALL® HCI®-TC for enclosed luminaires</b>									
HCI-TC 20/830 WDL PB	4008321052216	20	1700	G8.5	15	81	52	12	
HCI-TC 35/830 WDL PB	4050300876870	35	3500	G8.5	15	81	52	12	
HCI-TC 35/942 ND L PB	4050300873725	35	3400	G8.5	15	81	52	12	
HCI-TC 70/830 WDL PB <sup>1)</sup>	4050300793566	70	6900	G8.5	15	81	52	12	
HCI-TC 70/942 ND L PB	4008321003348	70	6600	G8.5	15	81	52	12	

**All HCI® lamps feature innovative POWERBALL® technology.**

POWERBALL® HCI®-TC lamps are compact metal halide lamps from OSRAM. They are single-ended, UV-reduced and allow luminaires to be made extremely compact. Approved for use only in enclosed luminaires.

**Benefits of POWERBALL® technology:**

- High luminous flux
- Best distribution of light
- Best color rendering
- Longest color constancy
- Small loss of luminous flux over lifetime
- Little dependency on burning position
- Full output available soon after switching the lamp on
- Lower failure rate due to ceramic corrosion

**Benefits of UV FILTER technology**

- Reduced brittleness of the plastics in luminaires
- The UV filter on the lamp meets the requirements of IEC 61167

**New "Secure Fix" G8.5 base from OSRAM**

"Secure Fix" means:

1. Mechanically stable base design for a secure fit
  2. Secure fit by decoupling the electrical contacts and positioning the lamp using holders with retaining springs
- "Secure Fix" bases can be used in all G8.5 holders that comply with the usual standards.

**Applications**

- Retail outlets
- Accent lighting
- Decorative lighting

1) In preparation  
 2) For HCI-TC 35, 70 W

## Metal halide lamps with ceramic technology POWERBALL® HCl®-TF for enclosed luminaires

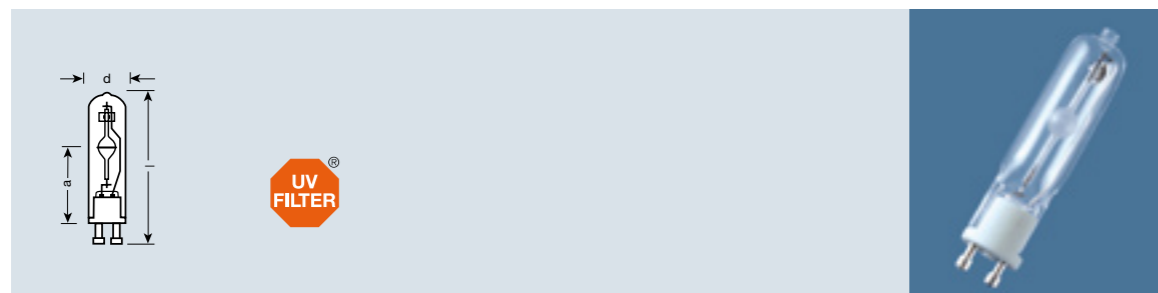

Product reference	Product number	W	lm					
<b>POWERBALL® HCl®-TF for enclosed luminaires</b>								
HCl-TF 20/830 WDL PB	4008321907615	20	1700	GU6.5	13	57	30	12
HCl-TF 35/830 WDL PB <sup>1)</sup>	4008321926678	35	3400	GU6.5	13	57	30	12

NEW

### All HCl® lamps feature innovative POWERBALL® technology.

POWERBALL® HCl®-TF is the smallest metal halide lamp from OSRAM. It is single-ended and UV-reduced.

Approved for use only in enclosed luminaires.

#### Benefits of POWERBALL® technology:

- High luminous flux
- Best distribution of light
- Best color rendering
- Longest color constancy
- Small loss of luminous flux over lifetime
- Little dependency on burning position
- Full output available soon after switching the lamp on
- Lower failure rate due to ceramic corrosion
- Plenty of light and very small dimensions

### Benefits of UV FILTER technology

- Reduced brittleness of the plastics in luminaires
- The UV filter on the lamp meets the requirements of IEC 61167

### New twist & lock GU6.5 base

- Robust
- Extremely simple handling
- Exact positioning of the lamp in the reflector

### Applications

Thanks to their small dimensions, HCl®-TF lamps are used wherever halogen lamps are the first choice. Thanks to the greater efficiency of HCl®-TF lamps, fewer luminaires are needed to produce the same brightness. Energy costs, installation costs and thermal loads are all therefore much lower.

## Metal halide lamps with ceramic technology POWERBALL® HCl®-T Shoplight for enclosed luminaires POWERBALL® HCl®-TC Shoplight for enclosed luminaires



Product reference	Product number	W	lm						
<b>POWERBALL® HCl®-T Shoplight for enclosed luminaires</b>									
HCl-T 35/930 WDL PB Shoplight <sup>1)</sup>	4008321108166	35	2800	G12	19	100	56	12	1
HCl-T 70/930 WDL PB Shoplight	4050300983134	70	6300	G12	19	100	56	12	1
<b>POWERBALL® HCl®-TC Shoplight for enclosed luminaires</b>									
HCl-TC 35/930 WDL PB Shoplight <sup>1)</sup>	4008321108142	35	2800	G8.5	15	81	52	12	2
HCl-TC 70/930 WDL PB Shoplight	4050300983110	70	6200	G8.5	15	81	52	12	2

### All HCl® lamps feature innovative POWERBALL® technology.

POWERBALL® HCl®-T Shoplight and POWERBALL® HCl®-TC Shoplight are ideal for displaying fabrics and food, and wherever color rendering and color matching are important criteria. They are single-ended and UV-reduced.

Approved for use only in enclosed luminaires.

### Benefits of POWERBALL® Shoplight

- Excellent color rendering: POWERBALL® Shoplight with color 930 WDL achieve a color rendering index greater than 95 for a warm white color (color rendering group 1A)
- Much improved red rendering
- Best distribution of light
- Longest color constancy
- Small loss of luminous flux over lifetime
- Little dependency on burning position
- Full output available soon after switching the lamp on
- Lower failure rate due to ceramic corrosion

### Benefits of UV FILTER technology

- Reduced brittleness of the plastics in luminaires
- The UV filter on the lamp meets the requirements of IEC 61167

### New "Secure Fix" G8.5 base from OSRAM for HCl-TC

"Secure Fix" means:

1. Mechanically stable base design for a secure fit
2. Secure fit by decoupling the electrical contacts and positioning the lamp using holders with retaining springs

"Secure Fix" bases can be used in all G8.5 holders that comply with the usual standards.

### Applications

- Prestige retail outlets and shop windows
- High-quality presentation of merchandise
- Museums and exhibitions

## Metal halide lamps with ceramic technology POWERBALL® HCI®-TS for enclosed luminaires



Product reference	Product number	W	lm						
<b>POWERBALL® HCI®-TS for enclosed luminaires</b>									
HCI-TS 70/830 WDL PB	4050300784069	70	6800	RX7s	20	120	60	12	1
HCI-TS 70/942 NDL PB	4050300784106	70	6500	RX7s	20	120	60	12	1
HCI-TS 150/830 WDL PB	4050300783987	150	14500	RX7s-24	23	138	69	12	1
HCI-TS 150/942 NDL PB	4050300784007	150	14400	RX7s-24	23	138	69	12	1
HCI-TS 250/830 WDL PB <sup>3)</sup>	4050300637730	250	25000	Fc2	25	162	81	12	2
HCI-TS 250/942 NDL PB <sup>1)3)</sup>	4008321907707	250	25000	Fc2	25	162	81	12	2

### All HCI® lamps feature innovative POWERBALL® technology.

POWERBALL® HCI®-TS lamps are double-ended UV-reduced lamps suitable for hot restart. Approved for use only in enclosed luminaires.

#### Benefits of POWERBALL® technology:

- High luminous flux
- Best distribution of light
- Best color rendering
- Longest color constancy
- Small loss of luminous flux over lifetime
- Little dependency on burning position
- Full output available soon after switching the lamp on
- Lower failure rate due to ceramic corrosion

#### Benefits of UV FILTER technology

- Reduced brittleness of the plastics in luminaires
- The UV filter on the lamp meets the requirements of IEC 61167

### Applications

- Prestige retail outlets
- High-quality presentation of merchandise
- Indirect lighting
- Museums, foyers and art galleries
- Building floodlighting and other outdoor applications

### Comments

- All POWERBALL® HCI®-TS lamps are approved for hot restart.
- POWERBALL® lamps produce more light than metal halide lamps of the same output with quartz technology or with cylindrical ceramic arc tubes. Fewer luminaires are needed to provide planned illuminance levels. Energy costs, installation costs and thermal loads are all therefore lower.

## Metal halide lamps with ceramic technology POWERBALL® HCI®-TP for open and enclosed luminaires

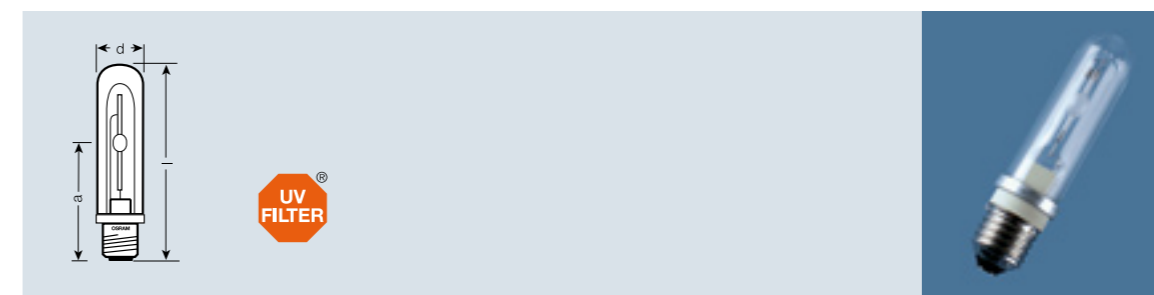

Product reference	Product number	W	lm					
<b>POWERBALL® HCI®-T/P for open and enclosed luminaires</b>								
clear								
HCI-T/P 70/830 WDL PB clear	4008321907714	70	6700	E27	32	128	89	12
HCI-T/P 70/942 NDL PB clear	4008321907738	70	6600	E27	32	128	89	12
HCI-T/P 100/830 WDL PB clear <sup>1)</sup>	4008321907752	100	9000	E27	40	133	89	12
HCI-T/P 100/942 NDL PB clear <sup>1)</sup>	4008321907776	100	8800	E27	40	133	89	12
HCI-T/P 150/830 WDL PB clear	4008321907790	150	14500	E27	40	133	89	12
HCI-T/P 150/942 NDL PB clear	4008321907813	150	14500	E27	40	133	89	12
coated								
HCI-T/P 70/830 WDL PB coated	4008321907721	70	6500	E27	32	128	-	12
HCI-T/P 70/942 NDL PB coated	4008321907745	70	6300	E27	32	128	-	12
HCI-T/P 100/830 WDL PB coated <sup>1)</sup>	4008321907769	100	8500	E27	40	133	-	12
HCI-T/P 100/942 NDL PB coated <sup>1)</sup>	4008321907783	100	8300	E27	40	133	-	12
HCI-T/P 150/830 WDL PB coated	4008321907806	150	14200	E27	40	133	-	12
HCI-T/P 150/942 NDL PB coated	4008321907820	150	14200	E27	40	133	-	12

### All HCI® lamps feature innovative POWERBALL® technology.

POWERBALL® HCI®-T/P lamps have been specially developed for use in open luminaires. They are single-ended and UV-reduced and have an E27 screw base.

Available in clear and coated versions. Approved for use in open and enclosed luminaires. Maximum protection against shattering thanks to integrated protective glass tube

#### Lamps for open luminaires:

Luminaires do not require shields, therefore

- lower luminaire costs
- easier to maintain
- luminaires easy to clean
- simple temperature management in the luminaire

#### Benefits of POWERBALL® technology:

- High luminous flux
- Best distribution of light
- Best color rendering
- Longest color constancy

- Small loss of luminous flux over lifetime
- Little dependency on burning position
- Full output available soon after switching the lamp on
- Lower failure rate due to ceramic corrosion

#### Benefits of UV FILTER technology

- Reduced brittleness of the plastics in luminaires
- The UV filter on the lamp meets the requirements of IEC 61167

### Applications

- Wallwashers indoors and outdoors
- Downlights in department stores, museums and exhibition halls
- Industrial lighting
- Outdoor floodlights

## Metal halide lamps with ceramic technology POWERBALL® HCI®-TT for enclosed luminaires

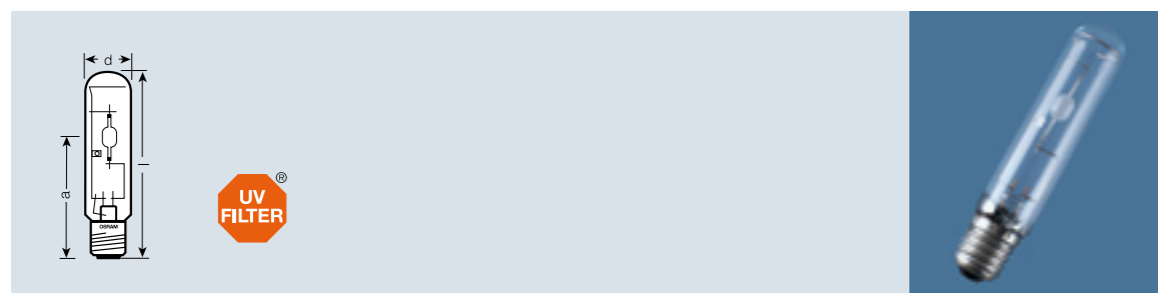

Product reference	Product number	W	lm					
<b>POWERBALL® HCI®-TT for enclosed luminaires</b>								
HCI-TT 70/830 WDL PB	4050300784120	70	7000	E27	32	155	102	12
HCI-TT 100/830 WDL PB <sup>1)</sup>	4008321931979	100	10000	E40	47	210	132	12
HCI-TT 150/830 WDL PB	4050300784144	150	14500	E40	47	210	132	12

NEW

### All HCI® lamps now feature innovative POWERBALL® technology.

POWERBALL® HCI®-TT lamps provide white light with special flair particularly for outdoor lighting. With E27 or E40 screw base. UV-reduced. Approved for use only in enclosed luminaires (see comments). Existing NAV fittings can be easily upgraded simply by replacing the lamp. The lamps start on NAV igniters and operate on NAV chokes of the appropriate rating. Brilliant white light creates a special atmosphere. Excellent color perception enhances safety.

#### Benefits of POWERBALL® technology:

- High luminous flux
- Best distribution of light
- Best color rendering
- Longest color constancy
- Small loss of luminous flux over lifetime
- Little dependency on burning position
- Full output available soon after switching the lamp on
- Lower failure rate due to ceramic corrosion

#### Benefits of UV FILTER technology

- Reduced brittleness of the plastics in luminaires
- The UV filter on the lamp meets the requirements of IEC 61167

#### Applications

- Prestige lighting for city centers, streets and parks
- Building floodlighting
- Roads and access routes to shopping centers and residential areas

#### Comments

- Because of their high operating pressure HCI-TT may only be operated in fully enclosed luminaires. In the rare case that a discharge vessel shatters, the luminaire must be able to retain all the hot pieces of ceramic or glass throughout their life.
- Where possible, use a timer igniter (switch-off time of at least 15 minutes). Otherwise, switch off the luminaire for at least 15 minutes if a brief interruption has occurred to the line voltage supply.

## Metal halide lamps with ceramic technology POWERBALL® HCI®-E/P for open and enclosed luminaires

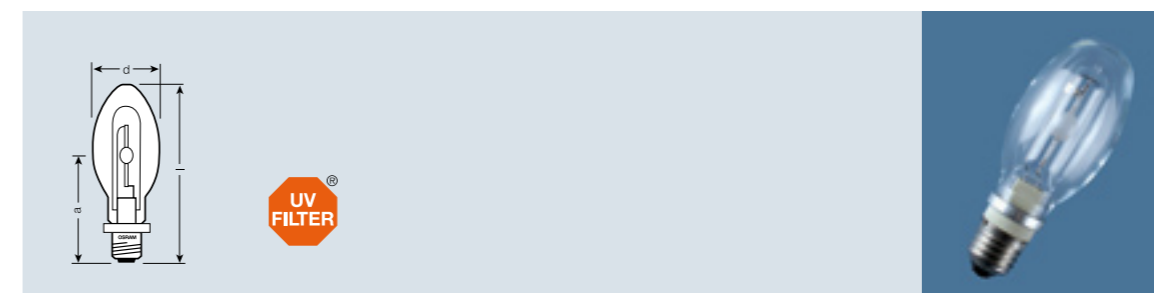

Product reference	Product number	W	lm					
<b>POWERBALL® HCI®-E/P for open and enclosed luminaires</b>								
clear								
HCI-E/P 35/830 WDL PB clear	4008321907837	35	3300	E27	54	138	86	12
HCI-E/P 35/942 ND L PB clear	4008321907851	35	3200	E27	54	138	86	12
HCI-E/P 70/830 WDL PB clear	4008321907875	70	7000	E27	54	138	86	12
HCI-E/P 70/942 ND L PB clear	4008321907899	70	6600	E27	54	138	86	12
HCI-E/P 100/830 WDL PB clear <sup>1)</sup>	4008321907912	100	9000	E27	54	138	86	12
HCI-E/P 100/942 ND L PB clear <sup>1)</sup>	4008321907936	100	8800	E27	54	138	86	12
HCI-E/P 150/830 WDL PB clear	4008321907950	150	14200	E27	54	138	86	12
HCI-E/P 150/942 ND L PB clear	4008321907974	150	14200	E27	54	138	86	12
coated								
HCI-E/P 35/830 WDL PB coated	4008321907844	35	3200	E27	54	138	-	12
HCI-E/P 35/942 ND L PB coated	4008321907868	35	3100	E27	54	138	-	12
HCI-E/P 70/830 WDL PB coated	4008321907882	70	6700	E27	54	138	-	12
HCI-E/P 70/942 ND L PB coated	4008321907905	70	6300	E27	54	138	-	12
HCI-E/P 100/830 WDL PB coated <sup>1)</sup>	4008321907929	100	8500	E27	54	138	-	12
HCI-E/P 100/942 ND L PB coated <sup>1)</sup>	4008321907943	100	8300	E27	54	138	-	12
HCI-E/P 150/830 WDL PB coated	4008321907967	150	13700	E27	54	138	-	12
HCI-E/P 150/942 ND L PB coated	4008321907981	150	13700	E27	54	138	-	12

### All HCI® lamps now feature innovative POWERBALL® technology.

POWERBALL® HCI®-E/P ellipsoidal lamps have been specially developed for use in open luminaires. They are single-ended with an E27 screw base, UV-reduced and are available in clear and coated versions. Approved for use in open and enclosed luminaires. Maximum protection against shattering thanks to integrated protective glass tube.

#### Lamps for open luminaires:

Luminaires do not require shields, therefore

- lower luminaire costs
- easier to maintain
- luminaires easy to clean
- simple temperature management in the luminaire

#### Benefits of POWERBALL® technology:

- High luminous flux
- Best distribution of light
- Best color rendering

- Longest color constancy
- Small loss of luminous flux over lifetime
- Little dependency on burning position
- Full output available soon after switching the lamp on
- Lower failure rate due to ceramic corrosion

#### Benefits of UV FILTER technology

- Reduced brittleness of the plastics in luminaires
- The UV filter on the lamp meets the requirements of IEC 61167

#### Applications

- Recessed ceiling downlights in offices, department stores, trade fairs and exhibitions
- Decorative open luminaires
- Indoor and outdoor applications
- Industrial lighting

## Metal halide lamps with ceramic technology POWERBALL® HCl®-E for enclosed luminaires

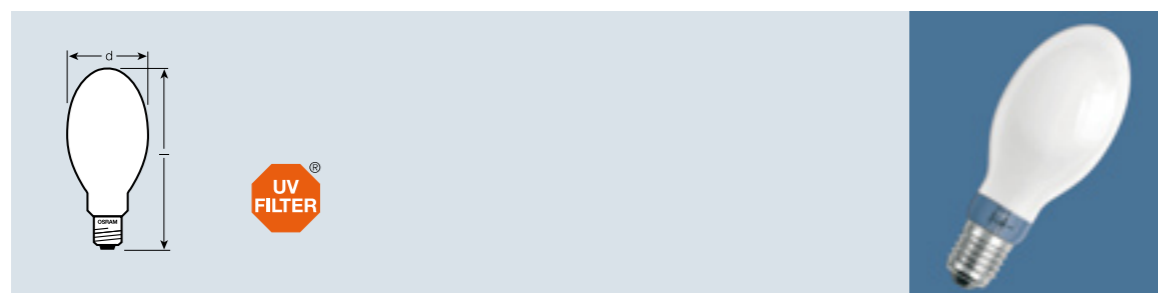

Product reference	Product number	W	lm				
<b>POWERBALL® HCl®-E for enclosed luminaires</b>							
HCl-E 250/830 WDL PB <sup>2)</sup>	4050300636825	250	24500	E40	91	226	12
HCl-E 250/942 NDL PB <sup>1)2)</sup>	4008321908315	250	22500	E40	91	226	12

### All HCl® lamps now feature innovative POWERBALL® technology.

Best ceramic technology in POWERBALL® HCl®-E ellipsoidal lamps with very high luminous flux and E40 screw base, UV-reduced. Approved for use only in enclosed luminaires.

#### Benefits of POWERBALL® technology:

- High luminous flux
- Best distribution of light
- Best color rendering
- Longest color constancy
- Small loss of luminous flux over lifetime
- Little dependency on burning position
- Full output available soon after switching the lamp on
- Lower failure rate due to ceramic corrosion

#### Benefits of UV FILTER technology

- Reduced brittleness of the plastics in luminaires
- The UV filter on the lamp meets the requirements of IEC 61167

#### Applications

Rapid upgrade for existing lighting solutions to provide better light colors.

- Atriums, museums and prestige offices
- Stations and factories
- Sports halls and other public buildings

## Metal halide lamps with ceramic technology POWERBALL® HCl®-R111 for open and enclosed luminaires

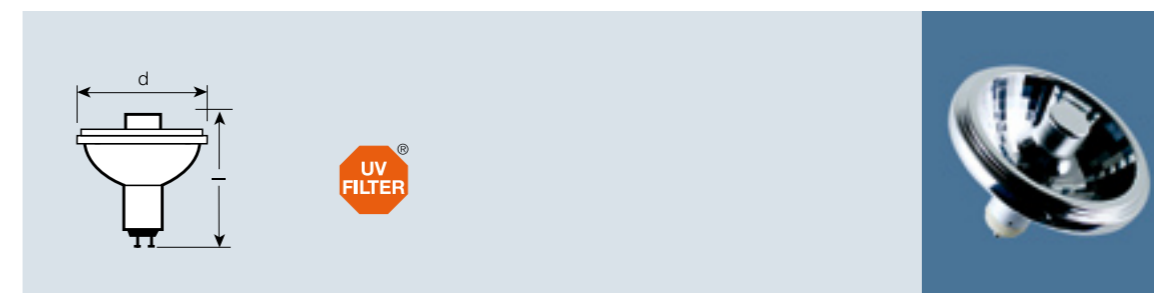

Product reference	Product number	W	cd					
<b>POWERBALL® HCl®-R111 for open and enclosed luminaires</b>								
HCl-R111 20/830 WDL PB 10D	4008321907998	20	19000	10	GX8.5	111	95	6
HCl-R111 20/830 WDL PB 24D	4008321908001	20	4400	24	GX8.5	111	95	6
HCl-R111 20/830 WDL PB 40D	4008321908018	20	2200	40	GX8.5	111	95	6
HCl-R111 35/830 WDL PB 10D	4008321908025	35	39000	10	GX8.5	111	95	6
HCl-R111 35/830 WDL PB 24D	4008321908032	35	9500	24	GX8.5	111	95	6
HCl-R111 35/830 WDL PB 40D	4008321908049	35	4500	40	GX8.5	111	95	6
HCl-R111 35/942 NDL PB 10D	4008321908056	35	39000	10	GX8.5	111	95	6
HCl-R111 35/942 NDL PB 24D	4008321908063	35	9500	24	GX8.5	111	95	6
HCl-R111 35/942 NDL PB 40D	4008321908070	35	4500	40	GX8.5	111	95	6
HCl-R111 70/830 WDL PB 10D <sup>1)</sup>	4008321908087	70	55000	10	GX8.5	111	95	6
HCl-R111 70/830 WDL PB 24D <sup>1)</sup>	4008321908094	70	16500	24	GX8.5	111	95	6
HCl-R111 70/830 WDL PB 40D <sup>1)</sup>	4008321908100	70	10000	40	GX8.5	111	95	6
HCl-R111 70/942 NDL PB 10D <sup>1)</sup>	4008321908117	70	55000	10	GX8.5	111	95	6
HCl-R111 70/942 NDL PB 24D <sup>1)</sup>	4008321908124	70	15000	24	GX8.5	111	95	6
HCl-R111 70/942 NDL PB 40D <sup>1)</sup>	4008321908131	70	9000	40	GX8.5	111	95	6

### All HCl® lamps now feature innovative POWERBALL® technology.

POWERBALL® HCl®-R111 with R111 reflector are approved for use in open luminaires and UV-reduced. At last a high-intensity solution with a modern R111 reflector, low thermal loading and long life. The new twist & lock GX8.5 base ensures stable positioning in the luminaire.

#### Lamps for open luminaires:

Luminaires do not require shields, therefore

- lower luminaire costs
- easier to maintain
- luminaires easy to clean
- simple temperature management in the luminaire

#### Benefits of POWERBALL® technology:

- High luminous flux
- Best distribution of light
- Best color rendering
- Longest color constancy
- Small loss of luminous flux over lifetime
- Little dependency on burning position
- Full output available soon after switching the lamp on
- Lower failure rate due to ceramic corrosion

#### Benefits of UV FILTER technology

- Reduced brittleness of the plastics in luminaires
- The UV filter on the lamp meets the requirements of IEC 61167

#### Applications

All indoor lighting systems, e.g. in shops, malls, museums, atriums, hotels and prestige rooms.

## Metal halide lamps with ceramic technology POWERBALL® HCI®-PAR for open and enclosed luminaires

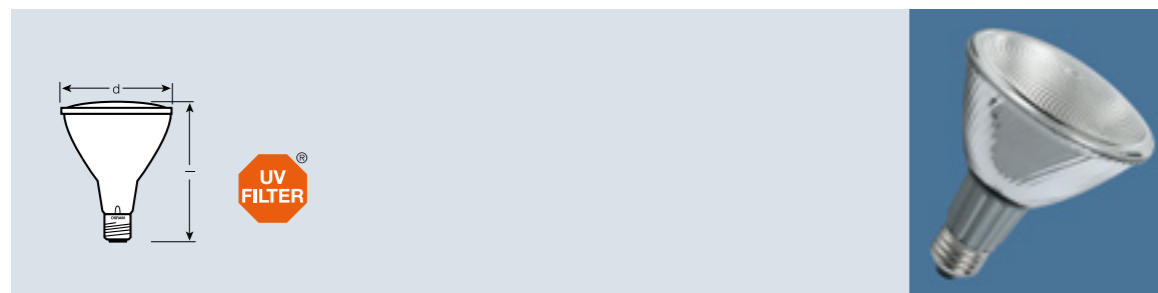

Product reference	Product number	W	cd					
<b>POWERBALL® HCI®-PAR for open and enclosed luminaires</b>								
HCI-PAR20 35/830 WDL PB 10D	4008321908162	35	24000	10	E27	65	95	12
HCI-PAR20 35/830 WDL PB 30D	4008321908179	35	5500	30	E27	65	95	12
HCI-PAR30 20/830 WDL PB 10D	4008321908148	20	24000	10	E27	97	125	6
HCI-PAR30 20/830 WDL PB 30D	4008321908155	20	4000	30	E27	97	125	6
HCI-PAR30 35/830 WDL PB 10D	4008321908209	35	46000	10	E27	97	125	6
HCI-PAR30 35/830 WDL PB 30D	4008321908216	35	8500	30	E27	97	125	6
HCI-PAR30 70/830 WDL PB 10D <sup>1)</sup>	4008321908247	70	70000	10	E27	97	125	6
HCI-PAR30 70/830 WDL PB 30D <sup>1)</sup>	4008321908254	70	14000	30	E27	97	125	6
HCI-PAR30 70/830 WDL PB 40D <sup>1)</sup>	4008321908261	70	9000	40	E27	97	125	6

### All HCI® lamps now feature innovative POWERBALL® technology.

POWERBALL® HCI®-PAR offers ceramic technology in PAR reflectors. With their tried and trusted screw bases and integrated reflectors, these lamps provide exciting new options for accent lighting. Because the reflector is integrated, designers can produce simple luminaires with optimum spotlighting or floodlighting properties. UV-reduced.

Approved for use in open and enclosed luminaires.

#### Lamps for open luminaires:

- Luminaires do not require shields, therefore
- lower luminaire costs
- easier to maintain
- luminaires easy to clean
- simple temperature management in the luminaire

#### Benefits of POWERBALL® technology:

- High luminous flux
- Best distribution of light
- Best color rendering
- Longest color constancy
- Small loss of luminous flux over lifetime
- Little dependency on burning position
- Full output available soon after switching the lamp on
- Lower failure rate due to ceramic corrosion

#### Benefits of UV FILTER technology

- Reduced brittleness of the plastics in luminaires
- The UV filter on the lamp meets the requirements of IEC 61167

#### Applications

- Retail outlets
- Accent lighting
- Decorative lighting
- Malls
- Industrial lighting
- Outdoors

## Metal halide lamps with quartz technology POWERSTAR® HQI®-T for enclosed luminaires

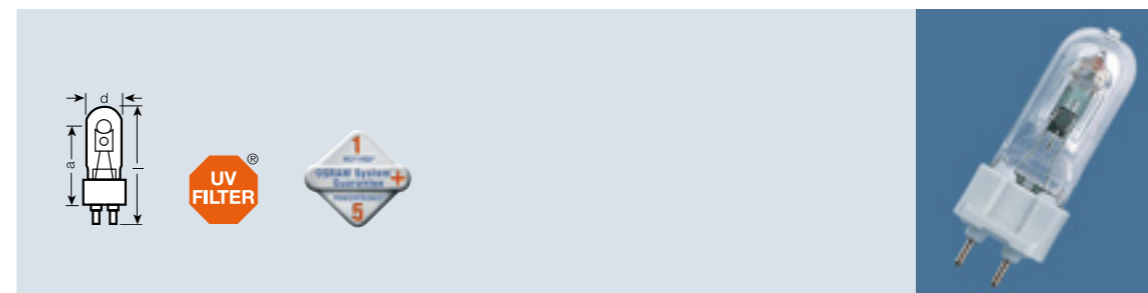

Product reference	Product number	W	lm					
<b>POWERSTAR® HQI®-T for enclosed luminaires</b>								
HQI-T 70/WDL	4050300872988	70	5300	G12	25	84	56	12
HQI-T 70/NDL	4050300873008	70	5800	G12	25	84	56	12
HQI-T 150/WDL	4050300872865	150	13000	G12	25	84	56	12
HQI-T 150/NDL	4050300872896	150	13000	G12	25	84	56	12

POWERSTAR® HQI®-T lamps are among the shortest metal halide lamps in the world for general lighting. Single-ended and UV-reduced. Approved for use only in enclosed luminaires. They are available in Warm White DE LUXE and Neutral White DE LUXE.

#### Benefits

- High luminous efficacy
- Excellent color rendering properties
- Long life
- High luminous flux
- Low thermal output
- The Warm White DE LUXE color combines well with the light from HALOSTAR® lamps

#### Benefits of UV FILTER technology

- Reduced brittleness of the plastics in luminaires
- The UV filter on the lamp meets the requirements of IEC 61167

#### Applications

- **Indoors:** Factories, shop interiors, shop windows, foyers, hotels, restaurants, trade fairs, exhibitions, offices, schools and sports halls, and for high-quality and economical architectural lighting
- **Outdoors:** Floodlighting, prestige roads, parks, building facades and monuments

#### Comments

- Burning position: For the horizontal burning position, mount the holder so that the lamp electrodes are not arranged one on top of the other

## Metal halide lamps with quartz technology POWERSTAR® HQI®-R for enclosed luminaires

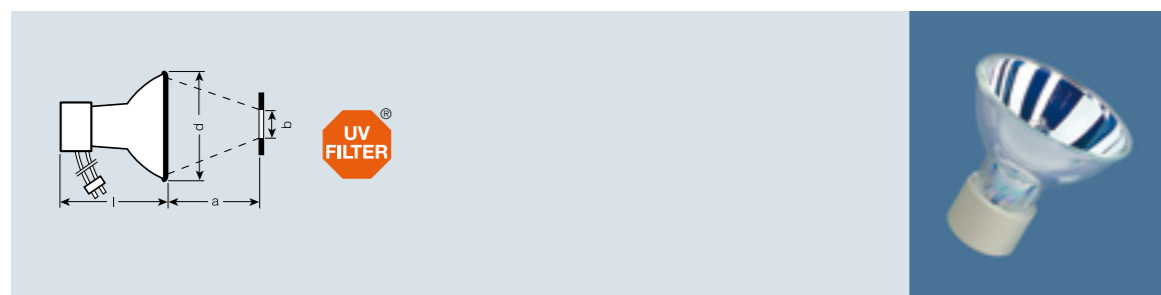

Product reference	Product number	W	cd	lm	Im	LCL	d max. [mm]	l max. [mm]	No.	
<b>POWERSTAR® HQI®-R for enclosed luminaires</b>										
HQI-R 150/NDL/FO	4050300465722	150	11000	5200 / 1850	75	-	95	93	12	

The POWERSTAR® HQI®-R lamp has a focusing dichroic reflector. Single-ended and UV-reduced. Approved for use only in enclosed luminaires.

### Benefits

- For compact optical systems with high efficiency in fiber-optic systems
- Optimum adjustment
- Low thermal load on the light guide
- Long life
- Quick and easy lamp replacement

### Benefits of UV FILTER technology

- Reduced brittleness of the plastics in luminaires
- The UV filter on the lamp meets the requirements of IEC 61167

### Applications

Light guide systems

## Metal halide lamps with quartz technology POWERSTAR® HQI®-TS for enclosed luminaires

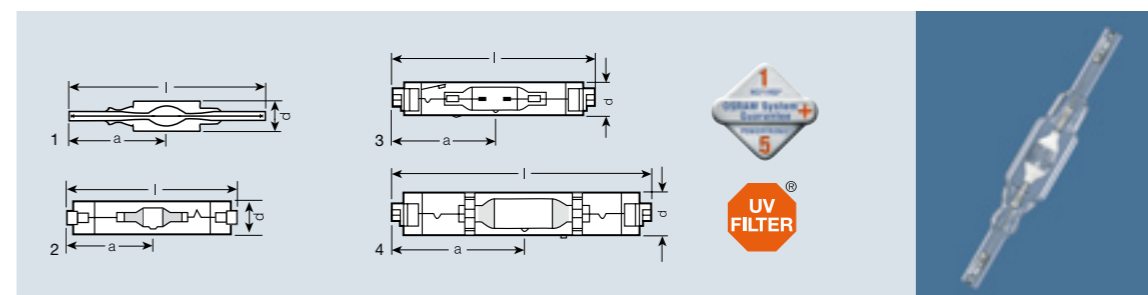

Product reference	Product number	W	lm	Im	LCL	d max. [mm]	l max. [mm]	a [mm]	No.	
<b>POWERSTAR® HQI®-TS EXCELLENCE for enclosed luminaires</b>										
HQI-TS 70/WDL EXCELLENCE <sup>1)</sup>	4008321149619	70	6000	RX7s	19	120	60	12	1	
HQI-TS 70/NDL EXCELLENCE <sup>1)</sup>	4008321149596	70	6500	RX7s	19	120	60	12	1	
HQI-TS 70/D EXCELLENCE <sup>1)</sup>	4008321149572	70	6200	RX7s	19	120	60	12	1	
HQI-TS 150/WDL EXCELLENCE <sup>1)</sup>	4008321149695	150	12000	RX7s-24	23	138	69	12	1	
HQI-TS 150/NDL EXCELLENCE <sup>1)</sup>	4008321149671	150	12500	RX7s-24	23	138	69	12	1	
HQI-TS 150/D EXCELLENCE <sup>1)</sup>	4008321149657	150	12000	RX7s-24	23	138	69	12	1	
<b>POWERSTAR® HQI®-TS for enclosed luminaires</b>										
HQI-TS 70/WDL <sup>2)</sup>	4050300412955	70	5100	RX7s	20	120	60	12	2	
HQI-TS 70/NDL <sup>2)</sup>	4050300412931	70	5700	RX7s	20	120	60	12	2	
HQI-TS 70/D <sup>2)</sup>	4050300437521	70	5500	RX7s	20	120	60	12	2	
HQI-TS 150/WDL <sup>2)</sup>	4050300412979	150	11700	RX7s-24	23	138	69	12	2	
HQI-TS 150/NDL <sup>2)</sup>	4050300362380	150	12000	RX7s-24	23	138	69	12	2	
HQI-TS 150/D <sup>2)</sup>	4050300437545	150	12000	RX7s-24	23	138	69	12	2	
<b>Fc2 base</b>										
HQI-TS 250/WDL	4050300436012	250	22000	Fc2	26	162	81	12	3	
HQI-TS 250/NDL	4050300436036	250	20000	Fc2	26	162	81	12	3	
HQI-TS 250/D	4050300436050	250	20000	Fc2	26	162	81	12	3	
HQI-TS 400/NDL <sup>3)</sup>	4050300304090	400	36000	Fc2	33	206	103	12	4	
HQI-TS 400/D <sup>4)</sup>	4050300015385	400	37000	Fc2	33	206	103	12	4	

NEW  
NEW  
NEW  
NEW  
NEW  
NEW

**POWERSTAR® HQI®-TS** lamps are compact double-ended UV-reduced lamps. Approved for use only in enclosed luminaires.

### Benefits of HQI-TS and -TS EXCELLENCE

- High luminous efficacy
- Excellent color rendering properties
- Long life
- High luminous flux
- Low thermal output
- The Warm White DE LUXE color combines well with the light from HALOSTAR® lamps

### Benefits of UV FILTER technology

- Reduced brittleness of the plastics in luminaires
- The UV filter on the lamp meets the requirements of IEC 61167

### POWERSTAR® HQI®-TS EXCELLENCE

Innovative development of the successful HQI-TS lamp in a new design. Fully compatible with previous HQI-TS lamps.

### Benefits of HQI-TS EXCELLENCE

- Better distribution of light
- Easier handling
- Smaller size, greater luminaire efficiency
- Higher luminous flux
- Plus all the benefits of HQI-TS

### Applications

- **Indoors:** Factories, shop interiors, shop windows, foyers, hotels, restaurants, trade fairs, exhibitions, offices, schools, sports halls, etc.
- **Outdoors:** Floodlighting, building facades and monuments

**Metal halide lamps with quartz technology**  
**POWERSTAR® HQI®-TS short arc, without outer bulb for encl. luminaires**  
**POWERSTAR® HQI®-TS long arc, without outer bulb for encl. luminaires**

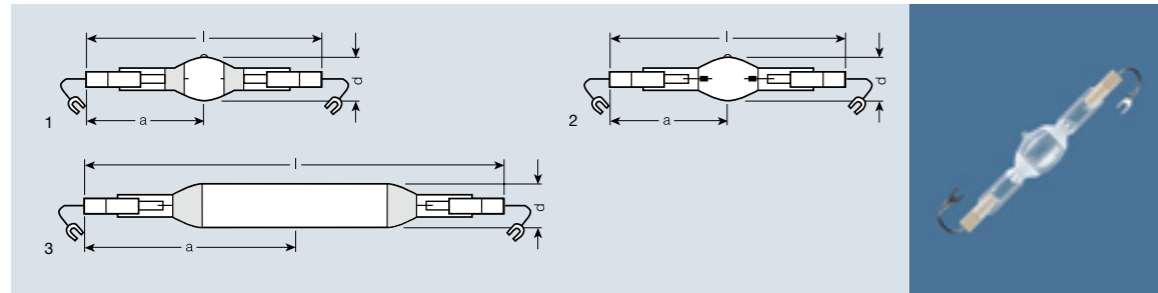

Product reference	Product number	W	lm							
<b>POWERSTAR® HQI®-TS short arc, without outer bulb for enclosed luminaires</b>										
HQI-TS 1000/NDL/S	4050300349916	1000	90000	K12s-36	36	187	93	10	1	
HQI-TS 1000/D/S	4050300300092	1000	90000	K12s-36	36	187	93	10	1	
HQI-TS 2000/NDL/S	4008321910196	2000	200000	K12s-36	36	187	93	10	1	
HQI-TS 2000/NDL/S/V <sup>1)</sup>	4008321195517	2000	200000	K12s-36	36	187	93	10	1	
HQI-TS 2000/D/S	4050300271682	2000	200000	K12s-36	36	187	93	10	2	
HQI-TS 2000/D/S/V <sup>1)</sup>	4050300977232	2000	200000	K12s-36	36	187	93	10	2	
<b>POWERSTAR® HQI®-TS long arc, without outer bulb for enclosed luminaires</b>										
HQI-TS 2000/N/L	4050300607344	2150	230000	K12s-36	32	274	137	10	3	
HQI-TS 2000/D/L	4008321931825	2150	205000	K12s-36	32	274	137	10	3	

POWERSTAR® HQI®-TS lamps (1000/2000 W) are compact double-ended UV-reduced lamps with no outer bulb. Approved for use only in enclosed luminaires.

**POWERSTAR® HQI®-TS 2000/D/S**  
**POWERSTAR® HQI®-TS 1000/NDL/S**

**Benefits**

- Extremely compact for small spotlights with low windage
- Extremely short arc for excellent directional light and very little scatter
- Excellent color rendering
- Can be used with conventional igniters and control gear
- Instant hot restart is possible with a special igniter

**Applications**

- Stadiums, sports halls, wide-area lighting, flood-lighting, solar simulation, material testing

**POWERSTAR® HQI®-TS 2000/N/L**

**Benefits**

- Arc length 120 mm
- Ideal for compact floodlights
- Can be used with conventional igniter and control gear

**Applications**

- Semi-professional sports arenas, training facilities, building spotlighting, factory sites

**Metal halide lamps with quartz technology**  
**POWERSTAR® HQI®-T for enclosed luminaires**  
**POWERSTAR® HQI®-T, without igniter for enclosed luminaires**

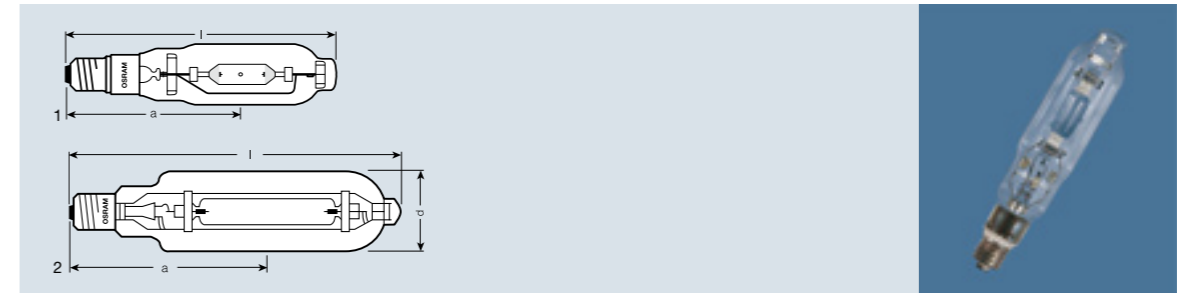

Product reference	Product number	W	lm							
<b>POWERSTAR® HQI®-T for enclosed luminaires</b>										
HQI-T 1000/N	4008321116604	1000	110000	E40	76	345	220	6	1	
HQI-T 1000/D	4050300015323	1000	85000	E40	76	345	220	6	1	
HQI-T 2000/N/E SUPER	4050300301860	2000	240000	E40	100	430	265	4	2	
HQI-T 2000/N/SN SUPER <sup>1)</sup>	4050300348629	2000	240000	E40	100	430	265	4	2	
HQI-T 2000/N/230 V	4050300421582	2000	190000	E40	100	430	265	4	2	
HQI-T 2000/D	4050300015330	2000	180000	E40	100	430	265	4	2	
<b>POWERSTAR® HQI®-T, without igniter for enclosed luminaires</b>										
HQI-T 2000/N	4050300015347	2000	205000	E40	100	430	265	4	2	
HQI-T 2000/D/I	4050300015446	2000	180000	E40	100	430	265	4	2	

The successful POWERSTAR® HQI® lamps with E40 screw bases are available in different light colors in 1000 W and 2000 W versions. Approved for use only in enclosed luminaires.

**Applications**

- High-ceiling rooms
- Sports halls and multi-purpose halls

**Benefits**

- Output of up to 2000 W
- Different light colors

**Metal halide lamps with quartz technology**  
**POWERSTAR® HQI®-T for enclosed luminaires**  
**POWERSTAR® HQI®-T, colored for enclosed luminaires**



Product reference	Product number	W	lm		d max. [mm]	l max. [mm]	LCL a [mm]		No.	
<b>POWERSTAR® HQI®-T for enclosed luminaires</b>										
HQI-T 250/D <sup>1)</sup>	4050300015293	250	20000	E40	46	226	150	12	1	
HQI-T 400/N <sup>1)2)</sup>	4050300324647	400	42000	E40	46	273	175	12	1	
HQI-BT 400/D <sup>1)2)</sup>	4050300468471	400	35000	E40	62	285	175	12	2	
<b>POWERSTAR® HQI®-T, colored for enclosed luminaires</b>										
HQI-T 400 BLUE <sup>3)</sup>	4050300575971	400	–	E40	46	275	175	12	1	
HQI-T 400 GREEN <sup>3)</sup>	4050300575957	400	–	E40	46	275	175	12	1	
HQI-T 400 MAGENTA <sup>3)</sup>	4050300649535	400	–	E40	46	275	175	12	1	

POWERSTAR® HQI®-T with medium output and E40 screw base. Approved for use only in enclosed luminaires.

**Applications**

- Industry
- Large halls
- Architecture lighting

**Benefits**

- Output of up to 400 W
- Different light colors
- Also available in BLUE, GREEN and MAGENTA

**Benefits of UV FILTER technology**

- Reduced brittleness of the plastics in luminaires
- The UV filter on the lamp meets the requirements of IEC 61167

**Metal halide lamps with quartz technology**  
**POWERSTAR® HQI®-E, clear, for open and enclosed luminaires**  
**POWERSTAR® HQI®-E, coated, for open and enclosed luminaires**

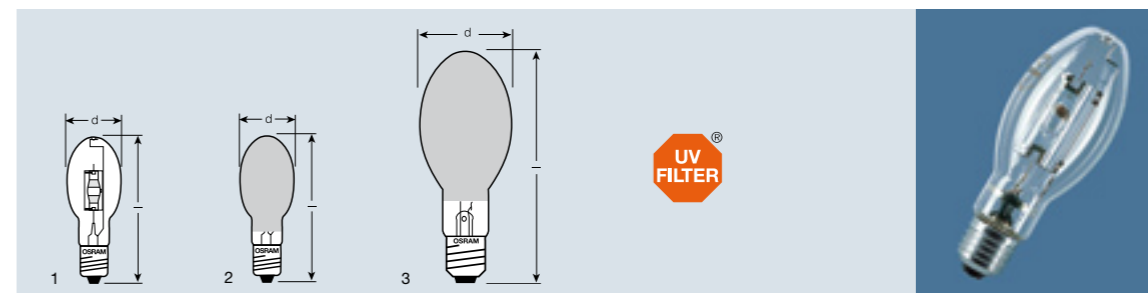

Product reference	Product number	W	lm		d max. [mm]	l max. [mm]	LCL a [mm]		No.	
<b>POWERSTAR® HQI®-E, clear, for open and enclosed luminaires</b>										
HQI-E 70/WDL clear <sup>1)</sup>	4050300397788	70	5200	E27	55	141	92	20	1	
HQI-E 70/NDL clear <sup>1)</sup>	4050300397825	70	5500	E27	55	141	92	20	1	
HQI-E 100/WDL clear <sup>1)</sup>	4050300351537	100	8500	E27	55	141	92	20	1	
HQI-E 100/NDL clear <sup>1)</sup>	4050300345871	100	8400	E27	55	141	92	20	1	
HQI-E 150/WDL clear <sup>1)</sup>	4050300433974	150	12900	E27	55	141	92	20	1	
HQI-E 150/NDL clear <sup>1)</sup>	4050300434018	150	12500	E27	55	141	92	20	1	
<b>POWERSTAR® HQI®-E, coated, for open and enclosed luminaires</b>										
HQI-E 70/WDL coated <sup>1)</sup>	4050300397801	70	4700	E27	55	141		20	2	
HQI-E 70/NDL coated <sup>1)</sup>	4050300397849	70	5100	E27	55	141		20	2	
HQI-E 100/WDL coated <sup>1)</sup>	4050300351551	100	7900	E27	55	141		20	2	
HQI-E 100/NDL coated <sup>1)</sup>	4050300345833	100	7700	E27	55	141		20	2	
HQI-E 150/WDL coated <sup>1)</sup>	4050300433998	150	11600	E27	55	141		20	2	
HQI-E 150/NDL coated <sup>1)</sup>	4050300434032	150	11500	E27	55	141		20	2	
HQI-E/P 250/D coated <sup>2)</sup>	4050300637457	250	17000	E40	90	226		12	3	
HQI-E/P 400/D coated <sup>2)3)</sup>	4050300637433	400	31000	E40	120	290		12	3	

POWERSTAR® HQI®-E lamps are single-ended ellipsoidal lamps, approved for open and enclosed luminaires and UV-reduced.

**Applications**

- Industry, offices and warehouses
- Outdoor lighting

**Benefits**

- E27 or E40 screw base for simple lamp handling
- Different light colors
- Available in clear and coated versions

**Comments**

- NAV® 100 W chokes and HQI® 150 W igniters are suitable for operating HQI®-E 100 W lamps.

**Benefits of UV FILTER technology**

- Reduced brittleness of the plastics in luminaires
- The UV filter on the lamp meets the requirements of IEC 61167

1) Operate with NAV® control gear  
 2) If operated with HQI® control gear see "Technical data", page 5.37  
 3) Lamps with virtually monochromatic light

1) Reduced color shift over lifetime, but has a faster loss of luminous flux. This may be offset by a lower planning factor.  
 2) Operate with NAV® control gear

3) If operated with HQI® control gear see "Technical data", page 5.37

**Metal halide lamps with quartz technology**  
**POWERSTAR® HQI®-E, clear, for enclosed luminaires**  
**POWERSTAR® HQI®-E, coated, for enclosed luminaires**

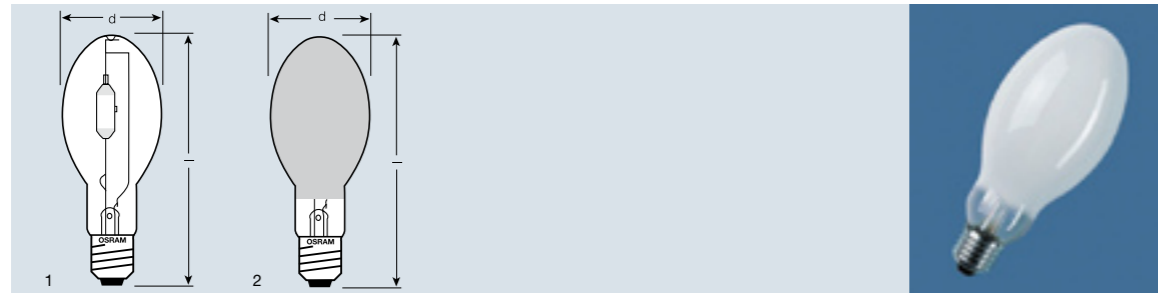

Product reference	Product number	W	lm							
<b>POWERSTAR® HQI®-E, clear, for enclosed luminaires</b>										
HQI-E 400/N clear <sup>1)2)</sup>	4050300292632	400	42000	E40	120	285	198	12	1	
<b>POWERSTAR® HQI®-E, coated, for enclosed luminaires</b>										
HQI-E 250/D <sup>1)</sup>	4050300015248	250	19000	E40	90	226	-	12	2	
HQI-E 400/D <sup>1)2)</sup>	4050300019727	400	34000	E40	120	290	-	12	2	
HQI-E 400/N <sup>1)2)</sup>	4050300305431	400	40000	E40	120	285	-	12	2	
HQI-E 1000/N	4050300015279	1000	100000	E40	165	380	-	6	2	

POWERSTAR® HQI®-E lamps are single-ended ellipsoidal lamps of medium to high wattage. Approved for use only in enclosed luminaires.

**Applications**

- Large halls
- Downlights in industry and department stores

**Benefits**

- Output of up to 1000 W
- Long life
- Good color rendering
- E40 screw base for simple lamp handling
- Available in clear and coated versions

1) Operate with NAV® control gear  
 2) If operated with HQI® control gear see "Technical data", page 5.37

**High-pressure sodium vapor lamps**  
**VIALOX® NAV®-E SUPER 4Y® VIALOX® NAV®-E 4Y®**  
**VIALOX® NAV®-E 4Y®, with integrated ignition unit**

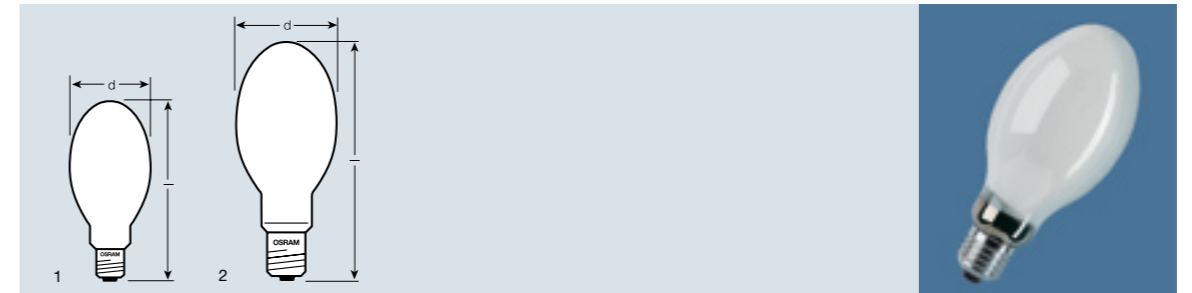

Product reference	Product number	W	lm					
<b>VIALOX® NAV®-E SUPER 4Y®<sup>1)</sup></b>								
NAV-E 100 SUPER 4Y	4050300015774	100	10200	E40	76	183	12	2
NAV-E 150 SUPER 4Y	4050300024370	150	17000	E40	91	226	12	2
NAV-E 250 SUPER 4Y	4050300024387	250	31100	E40	91	226	12	2
NAV-E 400 SUPER 4Y	4050300024394	400	55500	E40	122	290	12	2
<b>VIALOX® NAV®-E 4Y®</b>								
NAV-E 50 4Y	4050300577678	50	3500	E27	71	156	24	1
NAV-E 70 4Y	4050300577692	70	5600	E27	71	156	24	1
NAV-E 150 4Y	4050300577555	150	14500	E40	91	226	12	2
NAV-E 250 4Y	4050300577579	250	27000	E40	91	226	12	2
NAV-E 400 4Y	4050300577593	400	48000	E40	122	290	12	2
<b>VIALOX® NAV®-E 4Y®, with integrated ignition unit</b>								
NAV-E 50/I 4Y	4050300606033	50	3500	E27	71	156	24	1
NAV-E 70/I 4Y	4050300606019	70	5600	E27	71	156	24	1

**VIALOX® NAV® SUPER 4Y®**

VIALOX® NAV® SUPER 4Y® lamps are among the brightest and most economical high-pressure sodium lamps.

- Up to 25% longer life
- Greater reliability
- Up to 20% higher luminous efficacy
- Greater mast spacing
- Better lumen maintenance compared with standard high-pressure sodium lamps

**Applications**

- Street lighting
- Tunnel lighting
- Car parks and areas allocated to traffic
- Building floodlighting
- Factory lighting in heavy industry

**VIALOX® NAV® 4Y®**

Extremely economical long-life lamp

- Up to 25% longer life
- Greater reliability compared with standard high-pressure sodium lamps

1) Important: Before replacing for NAV® standard lamps in existing installations, check that the igniters are suitable

**High-pressure sodium vapor lamps**  
**VIALOX® NAV®-E (Standard)** **VIALOX® NAV®-E, with internal igniter**  
**VIALOX® NAV®-E Plug-in**

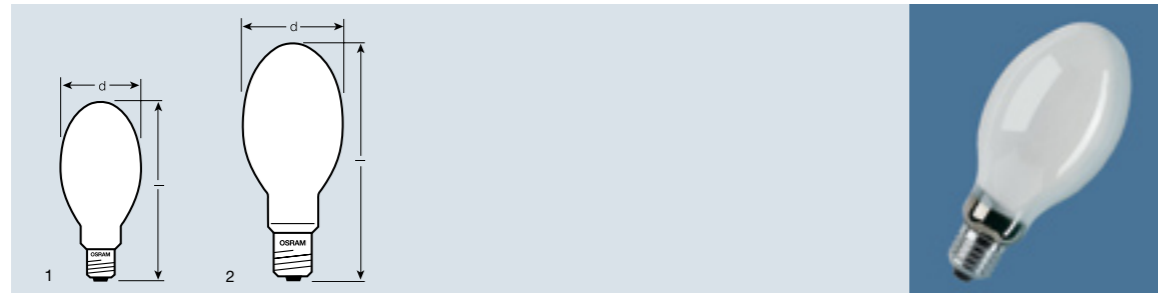

Product reference	Product number	W	lm		d max. [mm]	I max. [mm]		No.
<b>VIALOX® NAV®-E (Standard)</b>								
NAV-E 50/E	4050300015750	50	3500	E27	71	156	24	1
NAV-E 70/E	4050300015767	70	5600	E27	71	156	24	1
NAV-E 100	4008321087300	100	8500	E40	76	183	12	2
NAV-E 150 <sup>1)</sup>	4050300015613	150	14500	E40	91	226	12	2
NAV-E 250 <sup>1)</sup>	4050300015620	250	27000	E40	91	226	12	2
NAV-E 400 <sup>1)</sup>	4050300015637	400	48000	E40	122	290	12	2
NAV-E 1000	4050300015644	1000	120000	E40	165	370	6	2
<b>VIALOX® NAV®-E, with internal igniter</b>								
NAV-E 50/I	4050300015583	50	3500	E27	71	156	24	1
NAV-E 70/I	4050300015590	70	5600	E27	71	156	24	1
<b>VIALOX® NAV®-E Plug-in (substitute for mercury vapor lamp)</b>								
NAV-E 110	4050300024318	110	8000	E27	75	170	40	1
NAV-E 210	4050300015576	210	18000	E40	91	226	12	2
NAV-E 350	4050300015651	350	34000	E40	122	285	12	2

**VIALOX® NAV® with internal igniter**

Does not require a separate igniter. Lamps may only be operated with control gear for NAV® lamps. The lamps must not be operated in luminaires equipped with igniters.

**VIALOX® NAV®-E Plug-in**

The lamps can be used in luminaires for HQL® 125 W, 250 W or 400 W mercury vapor lamps without any modifications to the existing components, provided the control gear is suitable for the higher operating current of the NAV® Plug-in lamps. Check that the maximum permissible winding temperature as defined in VDE and IEC specifications are not exceeded. If in doubt, consult the manufacturer of the luminaire and/or control gear.

**High-pressure sodium vapor lamps**  
**VIALOX® NAV®-T SUPER 4Y®** **VIALOX® NAV®-T 4Y®**  
**VIALOX® NAV®-T (Standard)**

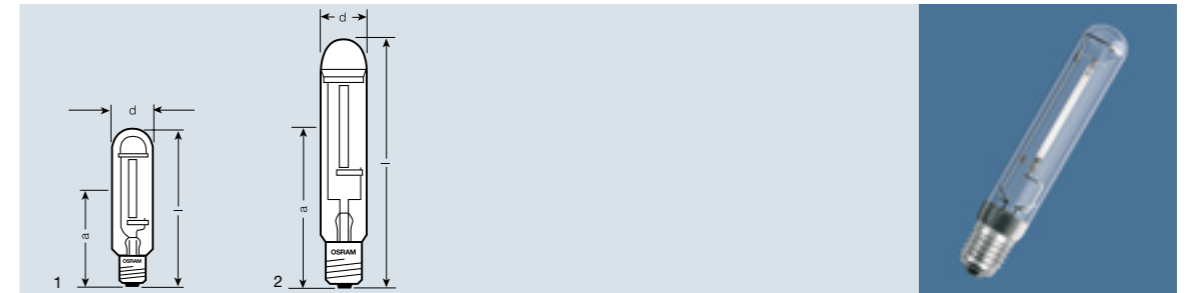

Product reference	Product number	W	lm		d max. [mm]	I max. [mm]	LCL a [mm]		No.
<b>VIALOX® NAV®-T SUPER 4Y®<sup>1)</sup></b>									
NAV-T 50 SUPER 4Y	4050300024325	50	4400	E27	38	156	104	12	1
NAV-T 70 SUPER 4Y	4050300015736	70	6600	E27	38	156	104	12	1
NAV-T 100 SUPER 4Y	4050300015743	100	10700	E40	47	210	132	12	2
NAV-T 150 SUPER 4Y	4050300024400	150	17500	E40	47	210	132	12	2
NAV-T 250 SUPER 4Y	4050300024417	250	33200	E40	47	257	158	12	2
NAV-T 400 SUPER 4Y	40503000281179	400	56500	E40	47	285	175	12	2
NAV-T 600 SUPER 4Y	4050300275772	600	90000	E40	47	285	175	12	2
<b>VIALOX® NAV®-T 4Y®</b>									
NAV-T 70 4Y	40503000579061	70	6000	E27	38	156	104	12	1
NAV-T 150 4Y	40503000577616	150	15000	E40	47	210	132	12	2
NAV-T 250 4Y	40503000577630	250	28000	E40	47	257	158	12	2
NAV-T 400 4Y	40503000577654	400	48000	E40	47	285	175	12	2
<b>VIALOX® NAV®-T (Standard)</b>									
NAV-T 70	40503000255590	70	6000	E27	38	156	104	12	1
NAV-T 100	4008321087287	100	9000	E40	47	210	132	12	2
NAV-T 150 <sup>2)</sup>	4050300015668	150	15000	E40	47	210	132	12	2
NAV-T 250 <sup>2)</sup>	4050300015675	250	28000	E40	47	257	158	12	2
NAV-T 400 <sup>2)</sup>	4050300015682	400	48000	E40	47	285	175	12	2
NAV-T 1000 <sup>3)</sup>	40503000251417	1000	130000	E40	66	355	240	12	2

**NAV® as a clear tubular lamp**

Clear tubular NAV® lamps enable light to be directed with great precision. For new street light installations, this means that the mast spacing can be greater. This applies in particular to NAV®-T Super 4Y® lamps with their extremely high luminous efficacy. Potential savings are considerable. The other product characteristics and possible applications are as described in previous pages.

## High-pressure sodium vapor lamps VIALOX® NAV®-TS SUPER 4Y® VIALOX® NAV®-TS (Standard)

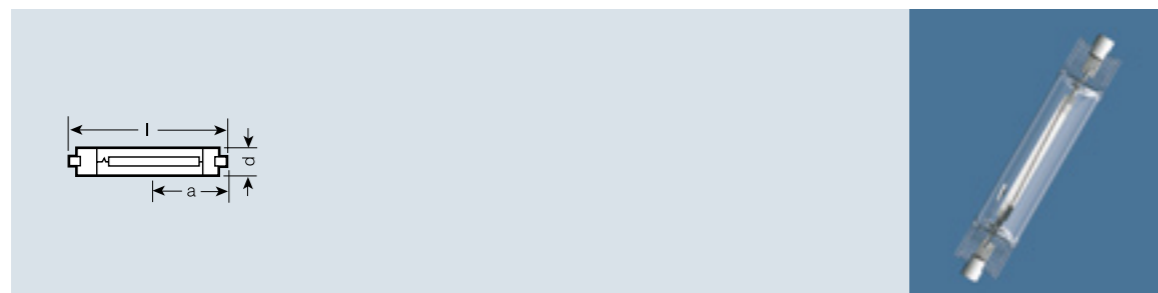

Product reference	Product number	W	lm					
<b>VIALOX® NAV®-TS SUPER 4Y®</b>								
NAV-TS 70 SUPER 4Y	4050300024301	70	6800	RX7s	20	120	60	12
NAV-TS 150 SUPER 4Y	4050300281667	150	15000	RX7s-24	23	138	69	12

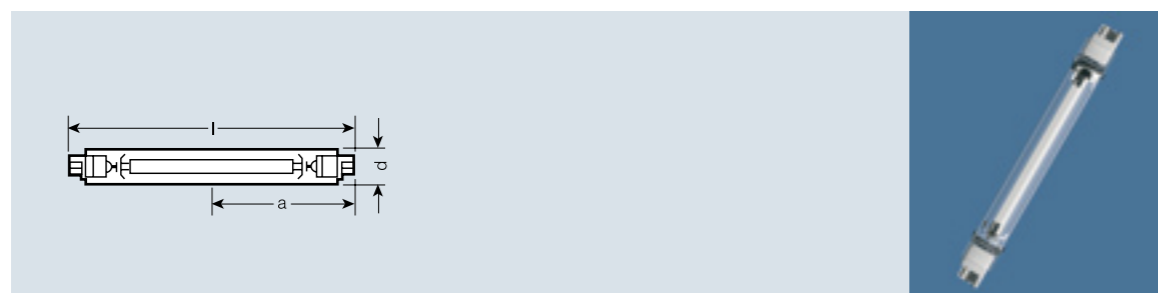

Product reference	Product number	W	lm					
<b>VIALOX® NAV®-TS (Standard)</b>								
NAV-TS 250	4050300015705	250	25500	Fc2	23	206	103	12
NAV-TS 400	4050300015712	400	48000	Fc2	23	206	103	12

### NAV® 4-year lamps

**VIALOX® NAV® SUPER 4Y® and NAV® 4Y®**  
4Y® stands for **4 Years**. With NAV® 4Y® lamps, the relamping interval for groups of sodium lamps in street lighting can be extended to four years.

#### Longer relamping intervals

NAV® lamps used to be replaced on a three-year cycle, so just by extending the relamping interval to four years the savings in annual lamp replacement costs amount to 25%.

#### Long-term reduction in premature failures

95% of NAV® 4Y® 50 to 400 W and NAV® SUPER 4Y® 50 to 400 W lamps are still operational after 16,000 hours. This leads to considerable additional savings in replacement costs.

## PLANTASTAR®

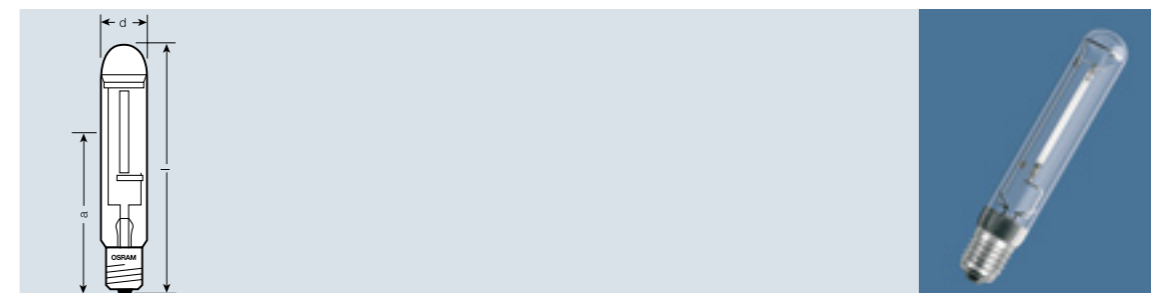

Product reference	Product number	W	lm					
<b>PLANTASTAR®</b>								
PLANTASTAR 250 inter	4008321240620	250	33200	E40	47	257	158	12
PLANTASTAR 400	4050300620084	400	56500	E40	47	285	175	12
PLANTASTAR 600	4050300620107	600	90000	E40	47	285	175	12

PLANTASTAR® lamps are ideal for additional lighting in the professional horticulture sector because they stimulate assimilation and growth in plants. This is particularly relevant for the production of cut flowers, vegetables, pot plants and seedlings.

#### Benefits

PLANTASTAR® lamps are designed to match the absorption spectrum of plants. The benefits for the professional horticulture sector are as follows:

- Shorter production times
- Healthier plants
- Control over blossoming

**PLANTASTAR® 400 W and 600 W lamps** enable plants to be intensively cultivated throughout the year.

**PLANTASTAR® inter** is rated at 250 W, making it ideal for use with tall vegetable varieties. The lamps are suspended as free-burning lamps between the plants.

## Low-pressure sodium lamps - SOX

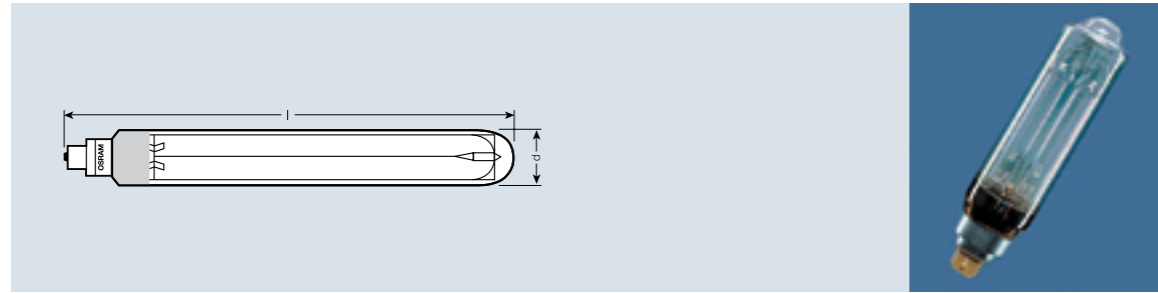

Product reference	Product number	W	lm				
<b>Low-pressure sodium lamps - SOX</b>							
SOX 18	40503000 <b>15569</b>	18	1800	BY22d	54	216	12
SOX 35	40503000 <b>15514</b>	35	4600	BY22d	54	311	12
SOX 55	40503000 <b>15521</b>	55	8100	BY22d	54	425	12
SOX 90	40503000 <b>15538</b>	90	13500	BY22d	68	528	12
SOX 135	40503000 <b>15545</b>	135	22500	BY22d	68	775	12
SOX 180	40503000 <b>15552</b>	180	32000	BY22d	68	1120	6

SOX low-pressure sodium lamps have a luminous efficacy of up to 178 lm/W.

### Applications

- Lighting for arterial roads and motorways, tunnels, canals and locks

### Benefit

- The emitted light has a monochromatic yellow color (sodium line 590 nm) for high-contrast visibility in mist and fog.

### Comments

Color perception not possible

Product reference	Product number	W	lm				
<b>SOX-E</b>							
SOX-E 26	4050300 <b>287713</b>	27	3500	BY22d	54	311	12
SOX-E 36	4050300 <b>287775</b>	35	5750	BY22d	54	425	12
SOX-E 66	4050300 <b>287799</b>	65	10700	BY22d	68	528	12
SOX-E 91	4050300 <b>287812</b>	90	17000	BY22d	68	775	12
SOX-E 131	4050300 <b>287836</b>	127	25000	BY22d	68	1120	9

### SOX-E

SOX-E lamps, in combination with optimised hybrid control gear, achieve luminous efficacies of up to 200 lm/W, the highest figure of any lamp.

## Mercury vapor lamps

HQL® 4Y HQL® SUPER DE LUXE HQL® DE LUXE HQL® (Standard)

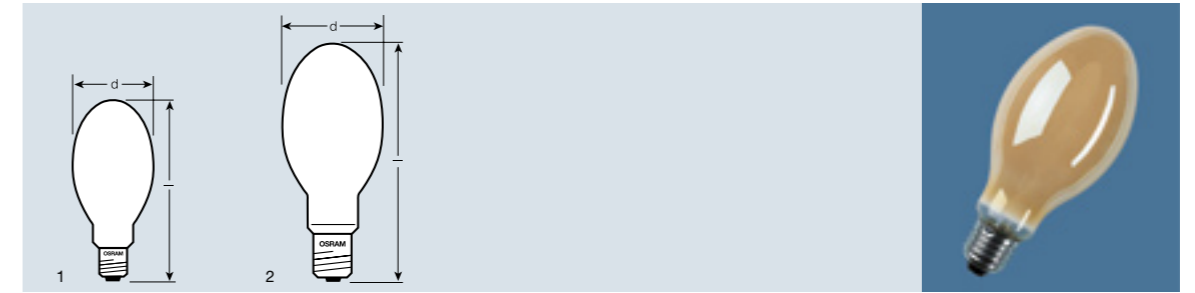

Product reference	Product number	W	lm					
<b>HQL® 4Y</b>								
HQL 50 4Y	400832 <b>1097859</b>	50	2000	E27	56	127	40	1
HQL 80 4Y	400832 <b>1097811</b>	80	4000	E27	71	155	40	1
HQL 125 4Y	400832 <b>1097835</b>	125	6800	E27	76	168	40	1
<b>HQL® SUPER DE LUXE</b>								
HQL 50 SUPER DE LUXE	40503000 <b>15217</b>	50	1600	E27	56	127	40	1
HQL 80 SUPER DE LUXE	40503000 <b>15224</b>	80	3400	E27	71	155	40	1
HQL 125 SUPER DE LUXE	40503000 <b>18515</b>	125	5700	E27	76	168	40	1
<b>HQL® DE LUXE</b>								
HQL 50 DE LUXE	40503000 <b>15132</b>	50	2000	E27	56	127	40	1
HQL 80 DE LUXE	40503000 <b>15149</b>	80	4000	E27	71	155	40	1
HQL 125 DE LUXE	40503000 <b>15156</b>	125	6800	E27	76	168	40	1
HQL 250 DE LUXE	40503000 <b>15163</b>	250	14000	E40	91	226	12	2
HQL 400 DE LUXE	40503000 <b>15170</b>	400	24000	E40	122	285	12	2
<b>HQL® (Standard)</b>								
HQL 50	40503000 <b>15040</b>	50	1800	E27	56	127	40	1
HQL 80	40503000 <b>12360</b>	80	3800	E27	71	155	40	1
HQL 125	40503000 <b>12377</b>	125	6300	E27	76	168	40	1
HQL 250	40503000 <b>15064</b>	250	13000	E40	91	226	12	2
HQL 400	40503000 <b>15071</b>	400	22000	E40	122	285	12	2
HQL 700	40503000 <b>15088</b>	700	40000	E40	141	325	6	2
HQL 1000	40503000 <b>15095</b>	1000	57000	E40	165	355	6	2

### HQL® 4Y

For 4 years of operation in street lighting. Compared to a 3-year relamping interval, 25% of annual maintenance costs can be saved. Warm white light color.

### HQL® SUPER DE LUXE

With its golden internal coating (photo see above), the long-life HQL® SUPER DE LUXE lamp provides a light color similar to that from an incandescent lamp, ideal for prestige lighting.

### HQL® DE LUXE

HQL® DE LUXE lamps have a warmer light color and emit more light than standard HQL® lamps, which makes them even more versatile.

### HQL® STANDARD

HQL® STANDARD-D high-pressure mercury lamps have an yttrium vanadate phosphor. Neutral white light color.

### Applications

- Outdoor lighting for squares, residential areas, parks, main roads and trunk roads
- Lighting for car parks and industrial sites
- Hall and effect lighting
- Decorative plant lighting

## Mercury vapor lamps HQL®-B SUPER DE LUXE HQL®-R DE LUXE

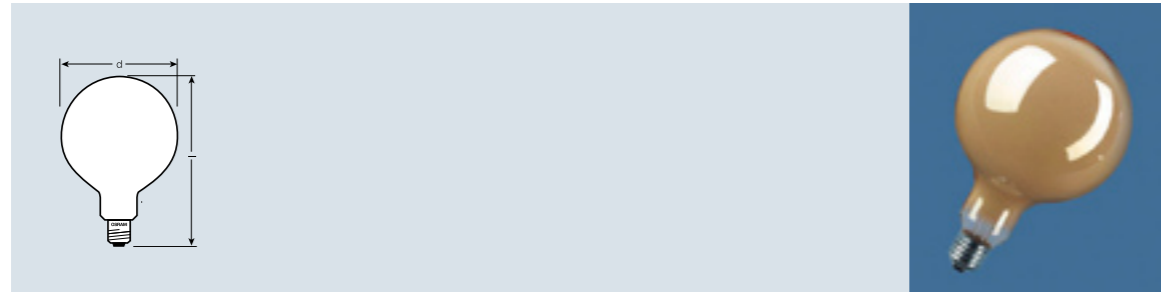

Product reference	Product number	W	lm		d max. [mm]	l max. [mm]	
<b>HQL®-B SUPER DE LUXE</b>							
HQL B 50 SUPER DE LUXE	4050300015194	50	1600	E27	126	190	6
HQL B 80 SUPER DE LUXE	4050300015200	80	3000	E27	126	190	6

Decorative HQL® SUPER DE LUXE lamps have a golden brown filter coating.

### Benefits

- Light color similar to that of an ordinary light bulb
- The spherical model is virtually glare-free and splash-proof thanks to the oversize bulb

### Applications

- **Indoors:** Particularly suitable for luminaires with one or more lamps (e.g. in foyers, shopping arcades, public rooms and other decorative lighting which requires long burning periods).
- **Outdoors:** Pedestrian precincts, parades, parks, gardens, footpaths and orientation lighting

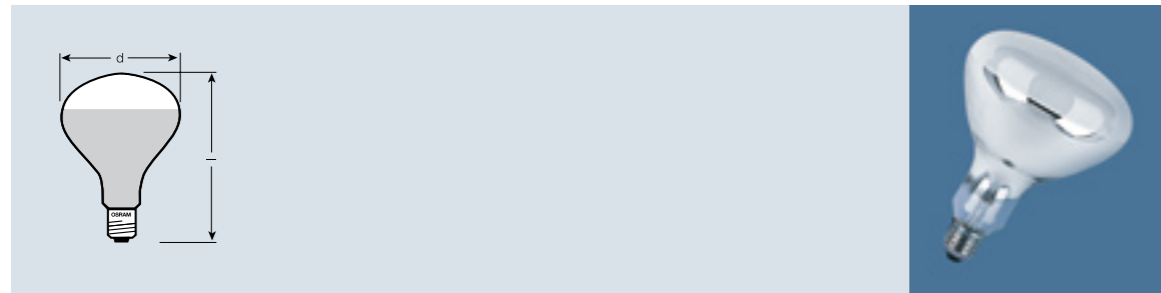

Product reference	Product number	W	lm		d max. [mm]	l max. [mm]	
<b>HQL®-R DE LUXE</b>							
HQL R 80 DE LUXE	4050300003290	80	3000	E27	125	168	6

The mushroom-shaped HQL®-R DE LUXE with reflector provides warm white light and pleasant color properties.

For luminous intensity distribution curves and illuminance see page 5.44.

### Applications

- Decorative lighting tasks that require long burning periods
- Plant lighting
- Aquariums, terrariums
- Protect against splashes

## Mercury mixed-light lamps HWL® HWL®-R Starter element

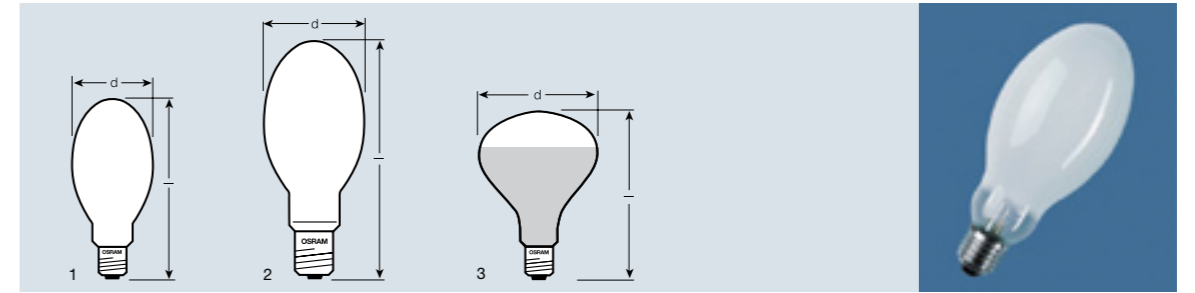

Product reference	Product number	W	lm		d max. [mm]	l max. [mm]		No.
<b>HWL®</b>								
HWL 160 225 V	4050300015453	160	3100	E27	76	168	40	1
HWL 160 235 V	4050300216867	160	3100	E27	76	168	40	1
HWL 250 225 V	4008321161123	250	5600	E40 <sup>1)</sup>	91	226	12	2
HWL 250 235 V	4008321159274	250	5600	E40	91	226	12	2
HWL 500 225 V	4050300015484	530	14000	E40	122	275	12	2
HWL 500 235 V	4050300216928	500	14000	E40	122	275	12	2
<b>HWL®-R</b>								
HWL R 160 DE LUXE	4050300015507	160	2500 <sup>2)</sup>	E27	125	168	6	3

HWL® mercury tungsten blended lamps have an yttrium vanadate phosphor.

### Benefits

- HWL® lamps can be used instead of incandescent lamps because they do not need either control gear or igniters
- Last longer than incandescent lamps

### Applications

- Factory and hall lighting with low-cost installations
- Upgrading light fittings with high-wattage incandescent lamps

Product reference	Product number		
<b>Starter element</b>			
STE 501	4050300839349	Replacement starter element for igniters	800

Some igniters for POWERSTAR® and VIALOX® are equipped with STE 501 (built-in glow starter). We recommend that STE 501 be replaced each time the lamp is replaced.

## Which lamp for which application?

Applications	POWER-BALL® HCl®	POWER-BALL® HCl® Shoplight	POWER-STAR® HQI®	HQL® DE LUXE	HQL® SUPER DE LUXE	HWL®	VIALOX® NAV® SUPER 4Y®	VIALOX® NAV® 4Y®	SOX
<b>Offices and administrative</b>									
buildings									
Open-plan offices, foyers	•	•	•						
Corridors	•		•						
Industry, trade and commerce									
Chemical and plastics industries	•		•	•	•				
Electrical, precision, wood and paper industries	•		•						
Foodstuffs	•	•	•						
Textiles, leather goods	•	•	•						
Printing	•	•	•						
Automotive and mech. industries	•		•	•					
Power stations and distr. heat. plants	•		•	•		•			
Laboratories	•	•	•	•					
Steel mills, foundries and gravel plants	•		•	•		•	•	•	•
Cement works	•		•	•			•	•	•
Warehouses, transport depots	•		•	•			•	•	
<b>Schools and</b>									
colleges									
Auditoriums, libraries	•	•	•						
Retail outlets									
Groceries, bakeries, delicatessen	•	•	•						
Textiles, leather goods	•	•	•						
Photo, watches, jewellery	•	•	•						
Cosmetics, hairdressers	•	•	•						
Flowers	•	•	•						
Supermarkets	•	•	•						
Department stores	•	•	•						
Public and amenity areas									
Foyers	•	•	•						
Restaurants	•	•	•						
Museums, art galleries	•	•	•						
Exhibition halls and trade fairs	•	•	•	•					
Sports halls and leisure centers	•		•						
<b>Hospitals and</b>									
surgeries									
Consulting and treatment rooms	•	•	•						
Traffic installations									
Main streets	•		•		•				
Pedestrian areas	•		•		•				
Arterial roads and motorways							•	•	•
Squares, bridges	•		•	•	•		•	•	•
Tunnels, subways	•		•				•	•	•
Side streets	•		•	•		•	•	•	•
Pedestrian crossings	•		•				•	•	•
Junctions	•		•	•			•	•	•
Parks and gardens	•		•	•	•	•			
Canals, locks							•	•	•
Railway yards							•	•	
Airports, aprons	•		•				•	•	
Industrial installations									
Factory yards, parking lots	•		•	•	•		•	•	•
Electrical plant	•		•	•	•		•	•	•
Shipyards, ports, quays	•		•	•	•		•	•	•
Mines, stockpiles, storage yards	•		•	•	•		•	•	•
Refineries	•		•				•	•	
Building sites									
Building sites	•		•	•			•	•	
Sports grounds									
Sports grounds	•		•				•		
Stadium floodlighting	•		•				•	•	
Flood-lighting									
Buildings, monuments	•		•	•			•	•	
Parks, gardens	•		•	•	•		•	•	
Special applications									
Plant lighting	•		•	• <sup>1)3)</sup>					
Aquariums, terrariums	• <sup>3)</sup>	• <sup>3)</sup>	• <sup>3)</sup>	• <sup>3)</sup>					
Horticulture	•		•			• <sup>2)</sup>			
Color film and TV productions	•	•	•						
Theater lighting	•	•	•						
Surface material testing	•	•	•						•
Color fastness testing	•	•	•						

For spectral power distributions see page 5.33

1) Specifically reflector lamps such as HQL®-R DE LUXE and HWL®-R DE LUXE  
 2) PLANTASTAR®  
 3) Splash-proof and jet-proof fittings only

## Relative spectral power distribution of discharge lamps

Visible range from 380 to 780 nm, relative spectral emission per 10 nm.

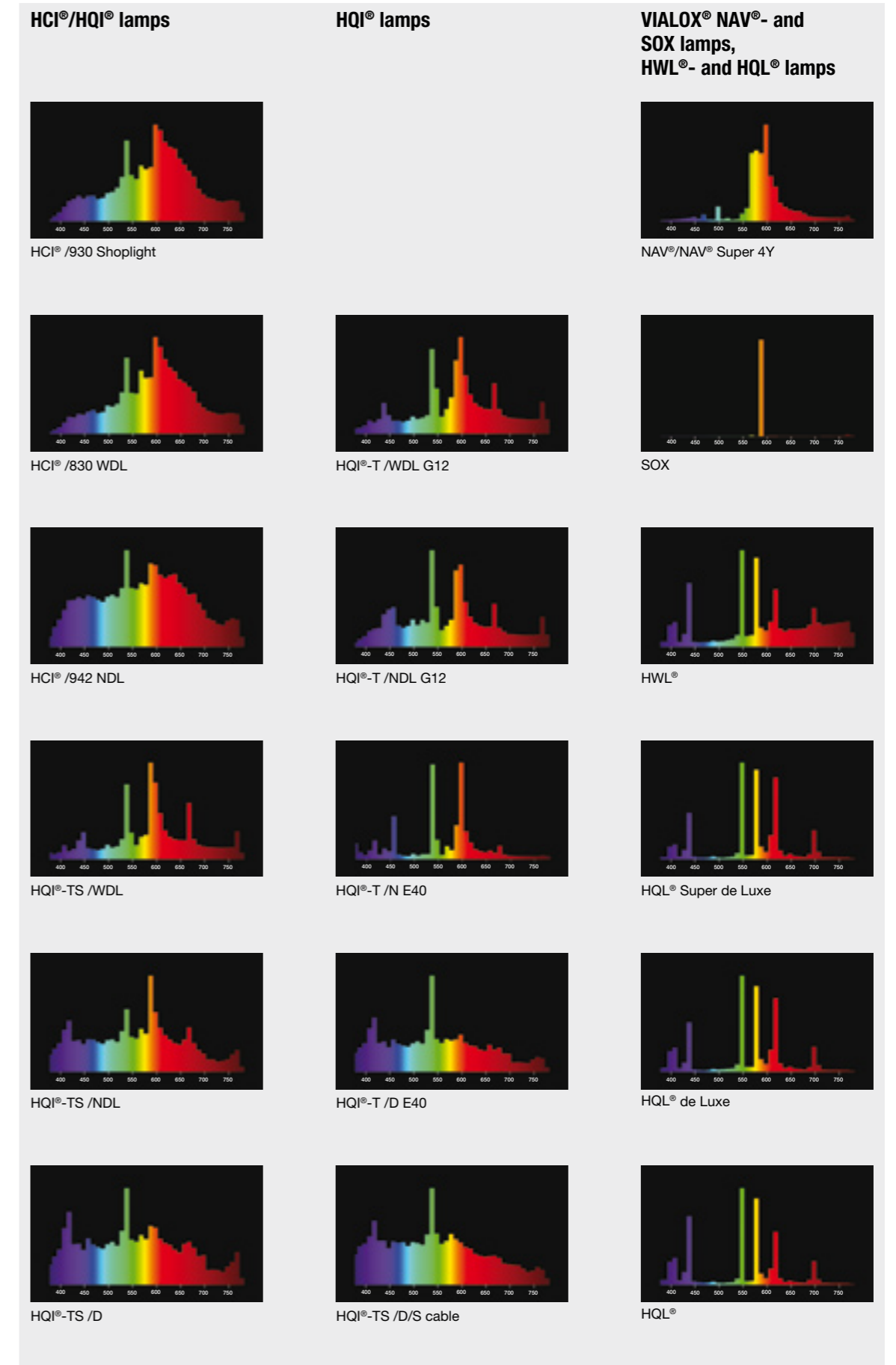

Note: These color graphs do not show the color distributions in great detail. The color printing process is not able to provide an accurate match between the colors shown and the colors defined for the individual color locations.

## Technical data

Product reference	Lamp current A	Lamp wattage W	PFC capacitor at 50 Hz $\mu\text{F}^{1)}$	Circuit diagram no. <sup>2)</sup>	Luminous flux lm	Luminous efficacy of lamp lm/W	Color rendering CRI	Color temperature K	Burning position <sup>3)</sup>
<b>POWERBALL® HCI®-T for enclosed luminaires</b>									
HCI-T 35/830 WDL PB <sup>4)</sup>	0,5	37	6	2/7	3600	95	83	3000	universal
HCI-T 35/942 ND L PB <sup>4)</sup>	0,5	37	6	2/7	3500	92	90	4200	universal
HCI-T 70/830 WDL PB <sup>4)</sup>	1,0	72	12	2/7	7300	100	88	3000	universal
HCI-T 70/942 ND L PB <sup>4)</sup>	1,0	72	12	2/7	6800	93	94	4200	universal
HCI-T 100/830 WDL PB <sup>4)6)</sup>	1,1	96	16	2/7	9500	99	86	3000	universal
HCI-T 100/942 ND L PB <sup>4)6)</sup>	1,2	96	16	2/7	9300	97	94	4200	universal
HCI-T 150/830 WDL PB <sup>4)</sup>	1,8	142	20	2/7	15000	106	88	3000	universal
HCI-T 150/942 ND L PB <sup>4)</sup>	1,8	146	20	2/7	14500	99	96	4200	universal
HCI-T 250/830 WDL PB <sup>5)</sup>	2,9	249	32	2	26000	104	92	3000	universal
HCI-T 250/942 ND L PB <sup>5)6)</sup>	2,9	255	32	2	25000	98	98	4200	universal
<b>POWERBALL® HCI®-TM for enclosed luminaires</b>									
HCI-TM 250/830 WDL PB <sup>5)</sup>	2,9	248	32	2	26000	104	92	3000	universal
HCI-TM 250/942 ND L PB <sup>5)</sup>	2,9	255	32	2	25000	98	98	4200	universal
HCI-TM 400/942 ND L PB <sup>5)6)</sup>	4,3	390	35	2	40000	103	95	4200	universal
<b>POWERBALL® HCI®-TC for enclosed luminaires</b>									
HCI-TC 20/830 WDL PB <sup>4)</sup>	0,2	20	ECG	7	1700	85	81	3000	universal
HCI-TC 35/830 WDL PB <sup>4)</sup>	0,5	37	6	2/7	3500	95	83	3000	universal
HCI-TC 35/942 ND L PB <sup>4)</sup>	0,5	39	6	2/7	3400	87	90	4200	universal
HCI-TC 70/830 WDL PB <sup>4)6)</sup>	1,0	72	12	2/7	6900	96	89	3000	universal
HCI-TC 70/942 ND L PB <sup>4)</sup>	1,0	74	12	2/7	6600	89	95	4200	universal
<b>POWERBALL® HCI®-TF for enclosed luminaires</b>									
HCI-TF 20/830 WDL PB <sup>4)</sup>	0,2	20	ECG	7	1700	85	85	3000	universal
HCI-TF 35/830 WDL PB <sup>4)6)</sup>	0,5	39	6	2/7	3400	87	85	3000	universal
<b>POWERBALL® HCI®-T Shoplight for enclosed luminaires</b>									
HCI-T 35/930 WDL PB Shoplight <sup>4)6)</sup>	0,5	39	6	2/7	2800	72	93	3000	universal
HCI-T 70/930 WDL PB Shoplight <sup>4)</sup>	1,0	71	12	2/7	6300	89	94	3000	universal
<b>POWERBALL® HCI®-TC Shoplight for enclosed luminaires</b>									
HCI-TC 35/930 WDL PB Shoplight <sup>4)6)</sup>	0,5	38	6	2/7	2800	74	93	3000	universal
HCI-TC 70/930 WDL PB Shoplight <sup>4)</sup>	1,0	73	12	2/7	6200	86	95	3000	universal
<b>POWERBALL® HCI®-TS for enclosed luminaires</b>									
HCI-TS 70/830 WDL PB <sup>4)</sup>	1,0	72	12	2/7	6800	94	88	3000	p45
HCI-TS 70/942 ND L PB <sup>4)</sup>	1,0	74	12	2/7	6500	88	95	4200	p45
HCI-TS 150/830 WDL PB <sup>4)</sup>	1,8	140	20	2/7	14500	104	90	3000	p45
HCI-TS 150/942 ND L PB <sup>4)</sup>	1,8	148	20	2/7	14400	97	95	4200	p45
HCI-TS 250/830 WDL PB <sup>5)</sup>	3,0	243	32	2	25000	103	90	3000	p45
HCI-TS 250/942 ND L PB <sup>5)6)</sup>	3,0	255	32	2	25000	98	98	4200	p45
<b>POWERBALL® HCI®-T/P for open and enclosed luminaires</b>									
HCI-T/P 70/830 WDL PB clear <sup>4)</sup>	1,0	73	12	2/7	6700	91	89	3000	universal
HCI-T/P 70/942 ND L PB clear <sup>4)</sup>	1,0	73	12	2/7	6600	89	96	4200	universal
HCI-T/P 100/830 WDL PB clear <sup>4)6)</sup>	1,2	96	16	2/7	9000	94	85	3000	universal
HCI-T/P 100/942 ND L PB clear <sup>4)6)</sup>	1,2	96	16	2/7	8800	92	94	4200	universal
HCI-T/P 150/830 WDL PB clear <sup>4)</sup>	1,8	145	20	2/7	14500	101	90	3000	universal
HCI-T/P 150/942 ND L PB clear <sup>4)</sup>	1,8	148	20	2/7	14500	98	95	4200	universal
HCI-T/P 70/830 WDL PB coated <sup>4)</sup>	1,0	73	12	2/7	6500	88	89	3000	universal
HCI-T/P 70/942 ND L PB coated <sup>4)</sup>	1,0	73	12	2/7	6300	89	95	4200	universal
HCI-T/P 100/830 WDL PB coated <sup>4)6)</sup>	1,2	96	16	2/7	8500	89	85	3000	universal
HCI-T/P 100/942 ND L PB coated <sup>4)6)</sup>	1,2	96	16	2/7	8300	86	94	4200	universal
HCI-T/P 150/830 WDL PB coated <sup>4)</sup>	1,8	145	20	2/7	14200	99	90	3000	universal
HCI-T/P 150/942 ND L PB coated <sup>4)</sup>	1,8	148	20	2/7	14200	96	95	4200	universal

## Technical data

Product reference	Lamp current A	Lamp wattage W	PFC capacitor at 50 Hz $\mu\text{F}^{1)}$	Circuit diagram no. <sup>2)</sup>	Luminous flux lm	Luminous efficacy of lamp lm/W	Color rendering CRI	Color temperature K	Burning position <sup>3)</sup>
<b>POWERBALL® HCI®-TT for enclosed luminaires</b>									
HCI-TT 70/830 WDL PB	0,9	72	12	2	7000	97	86	3000	universal
HCI-TT 100/830 WDL PB <sup>7)</sup>	1,8	98	16	2	10000	102	83	3000	universal
HCI-TT 150/830 WDL PB	1,8	136	20	2	14500	107	85	3000	universal
<b>POWERBALL® HCI®-E/P for open and enclosed luminaires</b>									
HCI-E/P 35/830 WDL PB clear <sup>4)</sup>	0,5	38	6	2/7	3300	87	85	3000	universal
HCI-E/P 35/942 ND L PB clear <sup>4)</sup>	0,5	39	6	2/7	3200	82	90	4200	universal
HCI-E/P 70/830 WDL PB clear <sup>4)</sup>	1,0	73	12	2/7	7000	96	88	3000	universal
HCI-E/P 70/942 ND L PB clear <sup>4)</sup>	1,0	73	12	2/7	6600	89	96	4200	universal
HCI-E/P 100/830 WDL PB clear <sup>4)7)</sup>	1,2	96	16	2/7	9000	94	88	3000	universal
HCI-E/P 100/942 ND L PB clear <sup>4)7)</sup>	1,2	96	16	2/7	8800	92	96	4200	universal
HCI-E/P 150/830 WDL PB clear <sup>4)</sup>	1,8	145	20	2/7	14200	98	93	3000	universal
HCI-E/P 150/942 ND L PB clear <sup>4)</sup>	1,8	146	20	2/7	14200	97	96	4200	universal
HCI-E/P 35/830 WDL PB coated <sup>4)</sup>	0,5	38	6	2/7	3200	84	85	3000	universal
HCI-E/P 35/942 ND L PB coated <sup>4)</sup>	0,5	39	6	2/7	3100	79	90	4200	universal
HCI-E/P 70/830 WDL PB coated <sup>4)</sup>	1,0	73	12	2/7	6700	92	88	3000	universal
HCI-E/P 70/942 ND L PB coated <sup>4)</sup>	1,0	73	12	2/7	6300	85	96	4200	universal
HCI-E/P 100/830 WDL PB coated <sup>4)7)</sup>	1,2	96	16	2/7	8500	89	88	3000	universal
HCI-E/P 100/942 ND L PB coated <sup>4)7)</sup>	1,2	96	16	2/7	8300	86	96	4200	universal
HCI-E/P 150/830 WDL PB coated <sup>4)</sup>	1,8	145	20	2/7	13700	94	93	3000	universal
HCI-E/P 150/942 ND L PB coated <sup>4)</sup>	1,8	146	20	2/7	13700	94	96	4200	universal
<b>POWERBALL® HCI®-E for enclosed luminaires</b>									
HCI-E 250/830 WDL PB <sup>5)</sup>	2,9	245	32	2	24500	100	91	3000	universal
HCI-E 250/942 ND L PB <sup>5)7)</sup>	2,9	250	32	2	22500	90	95	4200	universal
<b>POWERBALL® HCI®-R111 for open and enclosed luminaires</b>									
HCI-R111 20/830 WDL PB 10D <sup>4)</sup>	0,2	20	ECG	7	19000 <sup>6)</sup>	–	81	3000	universal
HCI-R111 20/830 WDL PB 24D <sup>4)</sup>	0,2	20	ECG	7	4400 <sup>6)</sup>	–	81	3000	universal
HCI-R111 20/830 WDL PB 40D <sup>4)</sup>	0,2	20	ECG	7	2200 <sup>6)</sup>	–	81	3000	universal
HCI-R111 35/830 WDL PB 10D <sup>4)</sup>	0,5	39	6	2/7	39000 <sup>6)</sup>	–	81	3000	universal
HCI-R111 35/830 WDL PB 24D <sup>4)</sup>	0,5	39	6	2/7	9500 <sup>6)</sup>	–	81	3000	universal
HCI-R111 35/830 WDL PB 40D <sup>4)</sup>	0,5	39	6	2/7	4500 <sup>6)</sup>	–	81	3000	universal
HCI-R111 35/942 ND L PB 10D <sup>4)</sup>	0,5	39	6	2/7	39000 <sup>6)</sup>	–	90	4200	universal
HCI-R111 35/942 ND L PB 24D <sup>4)</sup>	0,5	39	6	2/7	9500 <sup>6)</sup>	–	90	4200	universal
HCI-R111 35/942 ND L PB 40D <sup>4)</sup>	0,5	39	6	2/7	4500 <sup>6)</sup>	–	90	4200	universal
HCI-R111 70/830 WDL PB 10D <sup>4)7)</sup>	1,0	72	12	2/7	55000 <sup>6)</sup>	–	82	3000	universal
HCI-R111 70/830 WDL PB 24D <sup>4)7)</sup>	1,0	72	12	2/7	16500 <sup>6)</sup>	–	82	3000	universal
HCI-R111 70/830 WDL PB 40D <sup>4)7)</sup>	1,0	72	12	2/7	10000 <sup>6)</sup>	–	82	3000	universal
HCI-R111 70/942 ND L PB 10D <sup>4)7)</sup>	1,0	72	12	2/7	55000 <sup>6)</sup>	–	90	4200	universal
HCI-R111 70/942 ND L PB 24D <sup>4)7)</sup>	1,0	72	12	2/7	15000 <sup>6)</sup>	–	90	4200	universal
HCI-R111 70/942 ND L PB 40D <sup>4)7)</sup>	1,0	72	12	2/7	9000 <sup>6)</sup>	–	90	4200	universal
<b>POWERBALL® HCI®-PAR for open and enclosed luminaires</b>									
HCI-PAR20 35/830 WDL PB 10D	0,5	39	6	2/7	24000 <sup>6)</sup>	–	84	3000	universal
HCI-PAR20 35/830 WDL PB 30D	0,5	39	6	2/7	5500 <sup>6)</sup>	–	84	3000	universal
HCI-PAR30 20/830 WDL PB 10D	0,2	20	ECG	7	24000 <sup>6)</sup>	–	81	3000	universal
HCI-PAR30 20/830 WDL PB 30D	0,2	20	ECG	7	4000 <sup>6)</sup>	–	81	3000	universal
HCI-PAR30 35/830 WDL PB 10D	0,5	39	6	2/7	46000 <sup>6)</sup>	–	83	3000	universal
HCI-PAR30 35/830 WDL PB 30D	0,5	39	6	2/7	8500 <sup>6)</sup>	–	83	3000	universal
HCI-PAR30 70/830 WDL PB 10D <sup>7)</sup>	1,0	73	12	2/7	70000 <sup>6)</sup>	–	85	3000	universal
HCI-PAR30 70/830 WDL PB 30D <sup>7)</sup>	1,0	73	12	2/7	14000 <sup>6)</sup>	–	85	3000	universal
HCI-PAR30 70/830 WDL PB 40D <sup>7)</sup>	1,0	73	12	2/7	9000 <sup>6)</sup>	–	85	3000	universal

## Technical data

Product reference	Lamp current A	Lamp wattage W	PFC capacitor at 50 Hz $\mu\text{F}^{(1)}$	Circuit diagram no. <sup>(2)</sup>	Luminous flux lm	Luminous efficacy of lamp lm/W	Color rendering CRI	Color temperature K	Burning position <sup>(3)</sup>
<b>POWERSTAR® HQI®-T for enclosed luminaires</b>									
HQI-T 70/WDL <sup>(4)(7)</sup>	1,0	75	12	2/7	5300	71	76	3000	universal
HQI-T 70/NDL <sup>(4)(7)</sup>	1,0	75	12	2/7	5800	77	84	4200	universal
HQI-T 150/WDL <sup>(4)(7)</sup>	1,8	150	20	2/7	13000	87	77	3000	universal
HQI-T 150/NDL <sup>(4)(7)</sup>	1,8	150	20	2/7	13000	87	85	4200	universal
<b>POWERSTAR® HQI®-R for enclosed luminaires</b>									
HQI-R 150/NDL/FO <sup>(4)</sup>	1,8	150	20	2/7	11000	73	85	4200	p15
<b>POWERSTAR® HQI®-TS EXCELLENCE for enclosed luminaires</b>									
HQI-TS 70/WDL EXCELLENCE <sup>(4)(5)</sup>	1,0	78	12	2/7	6000	77	75	3000	p45
HQI-TS 70/NDL EXCELLENCE <sup>(4)(5)</sup>	1,0	78	12	2/7	6500	83	85	4200	p45
HQI-TS 70/D EXCELLENCE <sup>(4)(5)</sup>	1,0	78	12	2/7	6200	80	80	5600	p45
HQI-TS 150/WDL EXCELLENCE <sup>(4)(5)</sup>	1,8	150	20	2/7	12000	80	75	3000	p45
HQI-TS 150/NDL EXCELLENCE <sup>(4)(5)</sup>	1,8	150	20	2/7	12500	83	85	4200	p45
HQI-TS 150/D EXCELLENCE <sup>(4)(5)</sup>	1,8	150	20	2/7	12000	80	92	5600	p45
<b>POWERSTAR® HQI®-TS for enclosed luminaires</b>									
HQI-TS 70/WDL <sup>(4)(6)</sup>	1,0	75	12	2/7	5100	71	76	3000	p45
HQI-TS 70/NDL <sup>(4)(6)</sup>	1,0	73	12	2/7	5700	76	83	4000	p45
HQI-TS 70/D <sup>(4)(6)</sup>	1,0	75	12	2/7	5500	73	85	5200	p45
HQI-TS 150/WDL <sup>(4)(6)</sup>	1,8	150	20	2/7	11700	78	76	3000	p45
HQI-TS 150/NDL <sup>(4)(6)</sup>	1,8	150	20	2/7	12000	80	87	4200	p45
HQI-TS 150/D <sup>(4)(6)</sup>	1,8	150	20	2/7	12000	80	91	5200	p45
HQI-TS 250/WDL	2,8	250	32	2	22000	88	80	3200	p45
HQI-TS 250/NDL	3,0	250	32	2	20000	82	88	4200	p45
HQI-TS 250/D	3,0	250	32	2	20000	82	93	5100	p45
HQI-TS 400/NDL <sup>(10)</sup>	4,1	400	45	2	36000	90	88	4200	p45
HQI-TS 400/D <sup>(6)</sup>	4,1	400	45	2	37000	90	93	5200	p45
HQI-TS 400/D <sup>(5)</sup>	3,6	350	35	2	31000	89	90	5600	p45
<b>POWERSTAR® HQI®-TS short arc, without outer bulb for enclosed luminaires</b>									
HQI-TS 1000/NDL/S	9,2	1000	85	2	90000	90	> 85	4400	p15
HQI-TS 1000/D/S	9,4	1000	85	2	90000	90	≥ 90	5900	p15/s15
HQI-TS 2000/NDL/S <sup>(11)</sup>	11,3	1950	60	2/3	200000	103	> 85	4400	p15
HQI-TS 2000/NDL/S/V <sup>(11)(14)</sup>	11,3	1950	60	2/3	200000	103	> 85	4400	s15
HQI-TS 2000/D/S <sup>(11)</sup>	11,5 <sup>(13)</sup>	1950	60	2/3	200000	103	≥ 90	5900	p15
HQI-TS 2000 D/S/V <sup>(11)(14)</sup>	11,3 <sup>(13)</sup>	1950	60	2/3	200000	103	≥ 90	5900	s15
<b>POWERSTAR® HQI®-TS long arc, without outer bulb for enclosed luminaires</b>									
HQI-TS 2000/N/L	10,7	2150	60	2/3	230000	107	≥ 65	4400	p15
HQI-TS 2000/D/L	10,3	2150	60	2/3	205000	95	≥ 85	5400	p15
<b>POWERSTAR® HQI®-T for enclosed luminaires</b>									
HQI-T 1000/N	9,1	1000	85	2	110000	110	65	3500	p30
HQI-T 1000/D	8,9	1050	85	2	85000	81	90	7250	p30
HQI-T 2000/N/E SUPER	9,4	2000	37	2	240000 <sup>(12)</sup>	120	65	4400	p60
HQI-T 2000/N/SN SUPER <sup>(9)</sup>	9,4	2000	37	2	240000	120	65	4400	p60
HQI-T 2000/N/230 V <sup>(8)</sup>	16,5	1900	125	2	190000	100	65	4400	p30
HQI-T 2000/D	10,2	2050	60	2	180000	88	90	7250	p30

1) Typical value at rated voltage and  $\cos \varphi \geq 0.9$

2) For circuit diagrams see page 5.44

3) For examples see page 5.45

4) For the advantages of operation with POWERTRONIC® see Chapter 9

5) With HQI® control gear

6) Operate with NAV® control gear

7) For the horizontal burning position, mount the holder so that the lamp electrodes are not arranged one on top of the other

8) Specially developed for 230 V control gear. Excellent luminous flux behavior: 190,000 lumen after 4000 hours of operation

9) Lamps ignite at an ignition voltage of 0.9 to 1.3 kVs; lamps must not be operated with 4 to 5 kV igniters

10) Operate only with NAV® control gear

11) Lamps may be operated only on a 10.3 A ballast

12) 170,000 lm in the vertical burning position

13) Lamp current measured at a 10.3 A ballast

14) For vertical burning position, operate only with suitable thermal management

15) In preparation

16) Will be replaced by HQI-TS Excellence

## Technical data

Product reference	Lamp current A	Lamp wattage W	PFC capacitor at 50 Hz $\mu\text{F}^{(1)}$	Circuit diagram no. <sup>(2)</sup>	Luminous flux lm	Luminous efficacy of lamp lm/W	Color rendering CRI	Color temperature K	Burning position <sup>(3)</sup>
<b>POWERSTAR® HQI®-T, without igniter for enclosed luminaires</b>									
HQI-T 2000/N <sup>(9)</sup>	9,0	2000	37	1	205000 <sup>(10)</sup>	100	65	4000	p30
HQI-T 2000/D/I	10,3	2050	60	1	180000	88	90	7250	p30
<b>POWERSTAR® HQI®-T for enclosed luminaires</b>									
HQI-T 250/D <sup>(7)</sup>	3,0	250	32	2	20000	82	90	5200	universal <sup>(11)</sup>
HQI-T 400/N <sup>(7)</sup>	4,0	430	45	2	42000	98	> 65	3500	p45
HQI-T 400/N <sup>(6)</sup>	3,6	380	35	2	34000	89	> 60	4000	p45
HQI-BT 400/D <sup>(7)(8)</sup>	4,0	420	45	2	35000	83	90	5200	universal
HQI-BT 400/D <sup>(6)(8)</sup>	3,5	360	35	2	27000	75	90	5900	universal
<b>POWERSTAR® HQI®-T, colored for enclosed luminaires</b>									
HQI-T 400 BLUE <sup>(12)</sup>	3,6	360	35	2	–	–	–	–	p55
HQI-T 400 GREEN <sup>(12)</sup>	3,6	360	35	2	–	–	–	–	p55
HQI-T 400 MAGENTA <sup>(12)</sup>	4,2	440	45	2	–	–	–	–	p55
<b>POWERSTAR® HQI®-E, clear, for open and enclosed luminaires</b>									
HQI-E 70/WDL clear <sup>(4)(5)</sup>	1,0	73	12	2/7	5200	71	70	3000	universal
HQI-E 70/NDL clear <sup>(4)(5)</sup>	1,0	73	12	2/7	5500	75	70	4200	universal
HQI-E 100/WDL clear <sup>(4)(5)</sup>	1,1	100	16	2/7	8500	85	85	3000	universal
HQI-E 100/NDL clear <sup>(4)(5)</sup>	1,1	100	16	2/7	8400	84	70	4200	universal
HQI-E 150/WDL clear <sup>(4)(5)</sup>	1,8	150	20	2/7	12900	86	70	3000	universal
HQI-E 150/NDL clear <sup>(4)(5)</sup>	1,8	150	20	2/7	12500	83	80	4200	universal
<b>POWERSTAR® HQI®-E, coated, for open and enclosed luminaires</b>									
HQI-E 70/WDL coated <sup>(4)(5)</sup>	1,0	73	12	2/7	4700	64	70	2900	universal
HQI-E 70/NDL coated <sup>(4)(5)</sup>	1,0	73	12	2/7	5100	70	70	4000	universal
HQI-E 100/WDL coated <sup>(4)(5)</sup>	1,1	100	16	2/7	7900	79	80	2900	universal
HQI-E 100/NDL coated <sup>(4)(5)</sup>	1,1	100	16	2/7	7700	77	70	4000	universal
HQI-E 150/WDL coated <sup>(4)(5)</sup>	1,8	150	20	2/7	11600	77	70	2900	universal
HQI-E 150/NDL coated <sup>(4)(5)</sup>	1,8	150	20	2/7	11500	77	86	4000	universal
HQI-E/P 250/D coated <sup>(7)</sup>	3,0	250	32	2	17000	71	90	5200	universal
HQI-E/P 400/D coated <sup>(7)</sup>	3,9	420	45	2	31000	76	90	4700	universal
HQI-E/P 400/D coated <sup>(6)</sup>	3,7	360	35	2	25000	71	90	5200	universal
<b>POWERSTAR® HQI®-E, clear, for enclosed luminaires</b>									
HQI-E 400/N clear <sup>(4)(7)</sup>	4,0	440	45	2	42000	94	65	4000	h45
HQI-E 400/N clear <sup>(4)(6)</sup>	3,4	380	35	2	34000	90	60	4600	h45
<b>POWERSTAR® HQI®-E, coated, for enclosed luminaires</b>									
HQI-E 250/D <sup>(7)</sup>	3,0	250	32	2	19000	78	90	5200	universal
HQI-E 400/D <sup>(7)</sup>	3,8	460	45	2	34000	81	90	5300	universal
HQI-E 400/D <sup>(6)</sup>	3,6	400	35	2	26000	72	90	5500	universal
HQI-E 400/N <sup>(4)(7)</sup>	4,0	440	45	2	40000	94	65	3800	h45
HQI-E 400/N <sup>(4)(6)</sup>	3,4	380	35	2	34000	90	60	4400	h45
HQI-E 1000/N	9,5	1050	85	2	100000	91	65	3800	h45

1) Typical value at rated voltage and  $\cos \varphi \geq 0.9$

2) For circuit diagrams see page 5.44

3) For examples see page 5.45

4) For reduction in luminous flux see page 5.21, footnote 1)

5) For the advantages of operation with POWERTRONIC® see Chapter 9

6) With HQI® control gear

7) Operate with NAV® control gear

8) Data applies also to discontinued type HQI®-T 400 W/D

9) No igniter required

10) 170,000 lm in the vertical burning position

11) Color shifts are possible in the base-down burning position

12) Lamps with virtually monochromatic light

## Technical data

Product reference	Lamp current A	Lamp wattage W	PFC capacitor at 50 Hz $\mu\text{F}^{1)}$	Circuit diagram no. <sup>2)</sup>	Luminous flux lm	Luminous efficacy of lamp lm/W	Color rendering CRI	Color temperature K	Burning position <sup>3)</sup>
<b>VIALOX® NAV®-E SUPER 4Y®</b>									
NAV-E 100 SUPER 4Y	1,2	100	12	2	10200	102	≤ 25	2000	universal
NAV-E 150 SUPER 4Y	1,8	150	20	2	17000	113	≤ 25	2000	universal
NAV-E 250 SUPER 4Y	3,0	250	32	2	31100	124	≤ 25	2000	universal
NAV-E 400 SUPER 4Y	4,4	400	45	2	55500	139	≤ 25	2000	universal
<b>VIALOX® NAV®-E 4Y®</b>									
NAV-E 50 4Y	0,8	50	10	2	3500	70	≤ 25	2000	universal
NAV-E 70 4Y	1,0	70	12	2	5600	80	≤ 25	2000	universal
NAV-E 150 4Y	1,8	150	20	2	14500	97	≤ 25	2000	universal
NAV-E 250 4Y	3,0	250	32	2	27000	108	≤ 25	2000	universal
NAV-E 400 4Y	4,4	400	45	2	48000	120	≤ 25	2000	universal
<b>VIALOX® NAV®-E 4Y®, with integrated ignition unit</b>									
NAV-E 50/1 4Y <sup>4)</sup> 5)	0,8	50	10	1	3500	70	≤ 25	2000	universal
NAV-E 70/1 4Y <sup>4)</sup> 5)	1,0	70	12	1	5600	80	≤ 25	2000	universal
<b>VIALOX® NAV®-E (Standard)</b>									
NAV-E 50/E	0,8	50	10	2	3500	70	≤ 25	2000	universal
NAV-E 70/E	1,0	70	12	2	5600	80	≤ 25	2000	universal
NAV-E 100	1,2	100	12	2	8500	85	≤ 25	2000	universal
NAV-E 150	1,8	150	20	2	14500	97	≤ 25	2000	universal
NAV-E 250	3,0	250	32	2	27000	108	≤ 25	2000	universal
NAV-E 400	4,4	400	45	2	48000	120	≤ 25	2000	universal
NAV-E 1000	10,3	1000	100	2	120000	120	≤ 25	2000	universal
<b>VIALOX® NAV®-E, with internal igniter</b>									
NAV-E 50/1 <sup>4)</sup> 5)	0,8	50	10	1	3500	70	≤ 25	2000	universal
NAV-E 70/1 <sup>4)</sup> 5)	1,0	70	12	1	5600	80	≤ 25	2000	universal
<b>VIALOX® NAV®-E Plug-in (substitute for mercury vapour lamp)</b>									
NAV-E 110 <sup>4)</sup> 6)	1,3	110	10	1	8000	73	≤ 25	2000	universal
NAV-E 210 <sup>4)</sup> 6)	2,3	210	18	1	18000	86	≤ 25	2000	universal
NAV-E 350 <sup>4)</sup> 6)	3,6	350	25	1	34000	97	≤ 25	2000	universal
<b>VIALOX® NAV®-T SUPER 4Y®</b>									
NAV-T 50 SUPER 4Y	0,8	50	10	2	4400	88	≤ 25	2000	universal
NAV-T 70 SUPER 4Y	1,0	70	12	2	6600	94	≤ 25	2000	universal
NAV-T 100 SUPER 4Y	1,2	100	12	2	10700	107	≤ 25	2000	universal
NAV-T 150 SUPER 4Y	1,8	150	20	2	17500	116	≤ 25	2000	universal
NAV-T 250 SUPER 4Y	3,0	250	32	2	33200	133	≤ 25	2000	universal
NAV-T 400 SUPER 4Y	4,4	400	45	2	56500	141	≤ 25	2000	universal
NAV-T 600 SUPER 4Y	6,2	600	65	2	90000	150	≤ 25	2000	universal
<b>VIALOX® NAV®-T 4Y®</b>									
NAV-T 70 4Y	1,0	70	12	2	6000	86	≤ 25	2000	universal
NAV-T 150 4Y	1,8	150	20	2	15000	100	≤ 25	2000	universal
NAV-T 250 4Y	3,0	250	32	2	28000	112	≤ 25	2000	universal
NAV-T 400 4Y	4,4	400	45	2	48000	120	≤ 25	2000	universal
<b>VIALOX® NAV®-T (Standard)</b>									
NAV-T 70	1,0	70	12	2	6000	86	≤ 25	2000	universal
NAV-T 100	1,2	100	12	2	9000	90	≤ 25	2000	universal
NAV-T 150	1,8	150	20	2	15000	100	≤ 25	2000	universal
NAV-T 250	3,0	250	32	2	28000	112	≤ 25	2000	universal
NAV-T 400	4,4	400	45	2	48000	120	≤ 25	2000	universal
NAV-T 1000	10,3	1000	100	2	130000	130	≤ 25	2000	universal
<b>VIALOX® NAV®-TS SUPER 4Y®</b>									
NAV-TS 70 SUPER 4Y	1,0	70	12	2	6800	97	≤ 25	2000	p45
NAV-TS 150 SUPER 4Y	1,8	150	20	2	15000	100	≤ 25	2000	p45

## Technical data

Product reference	Lamp current A	Lamp wattage W	PFC capacitor at 50 Hz $\mu\text{F}^{1)}$	Circuit diagram no. <sup>2)</sup>	Luminous flux lm	Luminous efficacy of lamp lm/W	Color rendering CRI	Color temperature K	Burning position <sup>3)</sup>
<b>VIALOX® NAV®-TS (Standard)</b>									
NAV-TS 250	3,0	250	36	2	25500	102	≤ 25	2000	p45
NAV-TS 400	4,4	400	45	2	48000	120	≤ 25	2000	p45
<b>PLANTASTAR®</b>									
PLANTASTAR 250 inter	3,0	250	32	2	33200	133	≤ 25	2000	universal
PLANTASTAR 400	4,4	400	45	2	56500	141	≤ 25	2000	universal
PLANTASTAR 600	6,2	600	65	2	90000	150	≤ 25	2000	universal
<b>Low-pressure sodium lamps – SOX</b>									
SOX 18	0,4	18	5	4/5/6	1800 <sup>4)</sup>	100 <sup>4)</sup>	–	–	h150
SOX 35	0,6	36	20	4/5/6	4600 <sup>4)</sup>	128 <sup>4)</sup>	–	–	h110
SOX 55	0,6	57	20	4/5/6	8100 <sup>4)</sup>	142 <sup>4)</sup>	–	–	h110
SOX 90	0,9	91	26	4/5/6	13500 <sup>4)</sup>	148 <sup>4)</sup>	–	–	p20
SOX 135	0,9	135	20	4/5/6	22500 <sup>4)</sup>	167 <sup>4)</sup>	–	–	p20
SOX 180	0,9	184	20	4/5/6	32000 <sup>4)</sup>	174 <sup>4)</sup>	–	–	p20
<b>HQL® 4Y</b>									
HQL 50 4Y	0,6	50	7	1	2000	40	60	3400	universal
HQL 80 4Y	0,8	80	8	1	4000	50	60	3400	universal
HQL 125 4Y	1,2	125	10	1	6800	54	60	3400	universal
<b>HQL® SUPER DE LUXE</b>									
HQL 50 SUPER DE LUXE	0,6	50	7	1	1600	32	60	3200	universal
HQL 80 SUPER DE LUXE	0,8	80	8	1	3400	43	60	3200	universal
HQL 125 SUPER DE LUXE	1,2	125	10	1	5700	46	60	3200	universal
<b>HQL® DE LUXE</b>									
HQL 50 DE LUXE	0,6	50	7	1	2000	40	54	3400	universal
HQL 80 DE LUXE	0,8	80	8	1	4000	50	54	3400	universal
HQL 125 DE LUXE	1,2	125	10	1	6800	54	54	3400	universal
HQL 250 DE LUXE	2,2	250	18	1	14000	56	52	3400	universal
HQL 400 DE LUXE	3,3	400	25	1	24000	60	50	3400	universal
<b>HQL® (Standard)</b>									
HQL 50	0,6	50	7	1	1800	36	50	4200	universal
HQL 80	0,8	80	8	1	3800	48	50	4200	universal
HQL 125	1,2	125	10	1	6300	50	50	4200	universal
HQL 250	2,2	250	18	1	13000	52	46	4000	universal
HQL 400	3,3	400	25	1	22000	55	44	4000	universal
HQL 700	5,4	700	40	1	40000	57	43	4000	universal
HQL 1000	7,5	1000	60	1	57000	57	43	4000	universal
<b>HQL®-B SUPER DE LUXE</b>									
HQL B 50 SUPER DE LUXE	0,6	50	7	1	1600	32	60	3200	universal
HQL B 80 SUPER DE LUXE	0,8	80	8	1	3000	38	60	3200	universal
<b>HQL®-R DE LUXE</b>									
HQL R 80 DE LUXE	0,8	80	8	1	3000 <sup>5)</sup>	38	56	3400	universal
<b>HWL®</b>									
HWL 160 225 V	0,8	175	–	–	3100	18	62	3600	hs30
HWL 160 235 V	0,8	175	–	–	3100	18	62	3600	hs30
HWL 250 225 V	1,2	270	–	–	5600	21	58	3800	hs45
HWL 250 235 V	1,2	270	–	–	5600	21	58	3800	hs45
HWL 500 225 V	2,4	530	–	–	14000	27	60	4000	hs45
HWL 500 235 V	2,3	530	–	–	14000	27	60	4000	hs45
<b>HWL®-R</b>									
HWL R 160 DE LUXE	0,8	175	–	–	2500 <sup>5)</sup>	14	70	3200	hs15

## Operating instructions

### Supply voltage

The lamps must be connected via appropriate control gear.

A 230 V/50 Hz ac supply is generally required. HQI® 2000 W lamps are designed for 400 V/50 Hz (except HQI®-T 2000/N/230 V). If a different supply voltage is used, control gear with appropriate taps designed for these voltages must be used.

### Permitted line voltage deviation:

For HQL® ± 10%, all others ± 3%.

Sudden fluctuations in line voltage of more than ±10% may cause the lamps to go out. If the deviation from rated supply voltage (230 V or 400 V) is permanent, high-intensity discharge lamps may exhibit changes in chromaticity and luminous flux. Lamp life may also be reduced.

### Safety

OSRAM high-pressure lamps meet the safety requirements defined in IEC 62035.

The following lamps are UV-reduced:

HQI®/HCl® ≤ 400 W

Because of their high operating pressure the following lamps may only be used in fully enclosed luminaires designed to take them. In the rare case that a discharge vessel shatters, the luminaire must be able to retain all the hot pieces of ceramic or glass throughout their life.

This relates to the following lamps:

- All HCl®-TS and HQI®-TS lamps
- All HCl®-T and HQI®-T lamps
- All HCl®-TT lamps
- All HCl®-TC lamps
- All HCl®-TF lamps
- All HCl®-E ≥ 250 W and HQI®-E ≥ 250 W lamps
- HQI®-R 150 W/NDL lamps
- All HCl®-TM lamps

Operating lamps with a damaged outer bulb is dangerous and therefore not permitted. Exception: HQI®-TS ... without an outer bulb.

At the end of their lives, sodium high-pressure lamps and metal halide lamp exhibit a “rectification” effect. This is not a manufacturer-specific effect. Because of the excessive DC components, the control gear (ballasts, transformers and/or starters) may be overloaded. To meet the requirements of IEC 62035 therefore, suitable protective measures must be taken to ensure that safety is maintained under these conditions. This applies also to control gear with the option of power reduction. NAV PLUG-IN lamps have been developed specially as substitutes for mercury vapor lamps in existing luminaires and are therefore not affected.

The chokes and phase correction capacitors generally needed for operating discharge lamps may, under certain conditions, create oscillating circuits. These circuits may then produce excessive currents and voltages, which in turn can destroy the lamps, ballasts and capacitors. Such resonance phenomena must be avoided by appropriate circuits and fuses.

### Lamp operation

Operating high-pressure lamps for short periods in combination with frequent on/off switching will shorten their life. This applies to both cold starting and hot restarts. The lamps should be operated for at least 3 hours and should remain off for at least 30 minutes. This applies in particular to HQI® ≥ 1000 W. In low-temperature applications down to -50 °C only HCl®, HQI® and NAV® lamps are suitable for operation with an external igniter. Such applications call for special (heatable) igniters such as MZN 400 SU-LT from BAG Turgi (for lamps from 100 to 400 W). The following lamps are suitable for open luminaires:

- All HQI®-E 70 W to 150 W lamps
- All HQI®-E/P lamps
- All HCl®-E/P, HCl®-PAR, HCl®-R-111 and HCl®-T/P lamps

The use of shields should be considered for safety reasons in each case.

### Luminaire design

Luminaires must comply with IEC 60598

standard design (thermal characteristics and fuse protection).

HQI® 1000 W to 3500 W lamps should be held without pressure or by means of a lamp support close to the crown end. The same applies to NAV®-T 1000 W lamps in the horizontal burning position.

### Control gear

HWL®:

No control gear required; connect directly to supply. HCl®, HQI®, HQL®, NAV®:

- Control gear:
  - < 220 V high-reactance transformer,
  - ≥ 220 V choke.

For HQI®, HCl® and NAV® lamps, control gear with suitable overload protection should be used (see Safety).

- Igniters: HCl®, HQI® and NAV® lamps also need an appropriate igniter. (Exceptions: HQI®-T 2000/N, HQI®-T 2000/D/I, NAV®-E 50/I 4Y®, NAV®-E 70/I 4Y®, NAV®-E 50/I, NAV®-E 70/I, NAV®-E 110, NAV®-E 210, NAV®-E 350).

NAV® SUPER lamps require igniters with a higher ignition energy.

With suitable igniters or control gear HCl®-TM, HCl®/HQI®-TS and NAV®-TS lamps can be instantly restarted while hot (except HQI®-TS 2000/N/L).

SOX, SOX-E:  
Operation with high-reactance transformers (except SOX 18 tapped choke and 5 µF ignition capacitor) or hybrid control gear.

For the distances between the lamp and the control gear, check the information provided by the equipment manufacturer.

### Start-up current

HCl®, HQI®, HQL®, NAV®:

Depending on the control gear used, the start-up current may be up to twice as high as the operating current.

### Circuit protection

Fuses for HCl®, HQI® and NAV® lamps must be slow-acting. If fuse-wire is used it should be rated for twice the rated lamp current. If MCBs are provided they should comply with characteristic “C”.

## Operating instructions

### Holders

The holders used must be capable of withstanding the high voltages that occur during ignition and hot restarts. Suitable high-voltage holders can be ordered from lampholder manufacturers. A retainer is recommended for outdoor applications to prevent them coming loose (IEC 60238).

### Power factors

(without correction)

- HWL®:  $\cos \varphi \sim 1$
- HCl®, HQI® and HQL®:  $\cos \varphi$  0.5 to 0.7
- NAV®: With chokes  $\cos \varphi$  0.5
- SOX, SOX-E:  $\cos \varphi \sim 0.3$  (SOX 18:  $\cos \varphi \sim 0.9$ )

For the PFC capacitors required check the manufacturer's specifications. For examples see pages 5.34 to 5.39.

### Wattage reduction

**HQI® lamps must not be operated at reduced wattage as this may result in color shifts, poorer maintenance and shorter lamp life.**

In principle, POWERBALL® HCl® lamps can be dimmed.

The higher thermal load capacity of the round ceramic burner offers better dimming behavior in terms of luminous efficacy and color rendering compared to metal halide lamps with quartz burners or standard cylindrical ceramic burners. As before, however, dimming does lead to a change in the chromaticity coordinates. Lamps operated at dimmed settings suffer a greater loss of luminous flux and a greater color shift over their lifetime. OSRAM therefore recommends that the currently available lamps not be dimmed because the properties of POWERBALL® HCl® lamps change during dimming.

If lamps are to be dimmed, it is advisable only to use a controllable squarewave ECG and to dim down to no lower than 50% of the lamp power.

The lamp must be operated at 100% power for at least 15 minutes after a restart to ensure proper burn-in of the lamp.

**No guarantee can be made for POWERBALL® HCl® lamps that are operated at dimmed settings.**

### Switch on

HWL®: Instant full luminous flux. Starting current approx. 30% higher.

HQL®: Full luminous flux after approx. 5 minutes. Starting current approx. 40% higher.

HCl®: Full luminous flux after approx. 2 to 4 minutes. Starting current approx. 40% to 90% higher – depending on lamp type and control gear.

HQI®: Full luminous flux after approx. 2 to 4 minutes. Starting current approx. 40% to 90% higher – depending on lamp type and control gear.

NAV®: Full luminous flux after approx. 6 to 10 minutes depending on lamp type and control gear. Starting current approx. 25% higher.

SOX,  
SOX-E: Full luminous flux after approx. 12 to 15 minutes. Or longer at low ambient temperatures. No higher starting current.

### Restart

HCl®, HQI®, HQL®, HWL®, NAV®:

These lamps need a little time (0.25 to 15 minutes) to cool down before they can be restarted because the ignition voltage to begin with would be higher than the supply voltage or, in the case of HCl®, HQI® and NAV®, above the ignition voltage of the igniter.

For HCl®-TM, HCl®-TS, HQI®-TS ≤ 1000 W, HQI®-TS 2000/D/S and VIALOX® NAV®-TS lamps, instant restarting is possible with suitable igniters. The necessary restrike voltage is 25 to 60 kV.

SOX, SOX-E:

SOX 18 lamps can be instantly restarted. All other SOX lamps need a cooling time of a few minutes before they can be restarted.

### Radio interference

After ignition, radio interference does not normally occur with high pressure lamps. Should radio interference occur with HQL® lamps it can be avoided by connecting a low induction capacitor of 0.1 µF parallel to the lamp. Capacitors must not be connected parallel to any other high-pressure lamp. The requirements of DIN EN 50160 must be met.

### Photometric and electrical data

All lamp-specific electrical and photometric data is measured after 100 hours of operation under laboratory conditions on reference equipment. Despite the greatest care and attention during manufacture there will be luminous flux differences from batch to batch. This is due to the lamp physics involved and is inevitable. Unless otherwise indicated, the specified values for HQI® ≥ 1000 W apply to the horizontal burning position for -T and -TS types and for the base-up burning position for -E types. NAV® lamps are all measured in the horizontal burning position, and HQ and HW lamps in the base-up position. In other burning positions there may be considerable differences in the measured values, particularly the luminous flux, color temperature and life.

With the exception of SOX, the luminous flux is virtually unaffected by the ambient temperature outside the luminaire. At low ambient temperatures down to around -50 °C special igniters are needed. All POWERBALL® HCl®-TS ..., POWERSTAR® HQI®-TS ... and VIALOX® NAV®-TS ... lamps achieve their rated data at relatively high ambient temperatures, such as those in typical luminaires or luminaire simulators. Detailed information on thermal protection tubes (luminaire simulators) for determining lamp data for HQI®-TS and HCl®-TS can be found in IEC 61167, Section 1.7. NAV®-TS ... lamps should be treated similarly.

### Color shift

HQI® and HCl® lamps may show color shifts from lamp to lamp. These shifts may be due to external influences such as line voltage, control gear, burning position or luminaire design.

## Operating instructions

### End of service life

High pressure discharge lamps (HCl®, HQI®, NAV® and HQL®) can be considered to have reached the end of their service life if:

- there is a marked change in their color or
- there is a significant loss of brightness or
- the lamp no longer ignites or
- the lamp periodically goes out and comes on again.

To protect the control gear and to avoid unnecessary radio interference, HCl®, HQI®, NAV® and HQL® lamps must be replaced as soon as they reach the end of their service life.

### Warranty

High-intensity discharge lamps are only guaranteed if all operating conditions are observed; in other words, if the maximum permissible lamp temperatures are not exceeded and the lamps are operated only with control gear that has been approved or declared as suitable.

## OSRAM System + guarantee for HCl/HQI and PTi

Lamps	HCl-T 35, 70, 150 W HCl-TS 70, 150 W HCl-TC 35, 70 W HQI-T 70, 150 W HQI-TS 70, 150 W	1-year guarantee for up to 4000 hours for initial equipment IEC switching cycle
ECGs	PTi 35 S, I, PTi 2 x 35 S, I PTi 70 S, I, PTi 2 x 70 S, I PTi 150 S, I	5-year guarantee

- At least 25 fittings
- Operation at 100% output, not at reduced power
- Not for outdoor applications
- For more information on the system guarantee and the terms and conditions of the guarantee go to [www.osram.com/system-guarantee](http://www.osram.com/system-guarantee)
- Registration required:  
[www.osram.de/systemgarantie](http://www.osram.de/systemgarantie) – [www.osram.com/system-guarantee](http://www.osram.com/system-guarantee)

## Circuit diagrams

### Luminous intensity distribution of reflector lamps

These **circuit diagrams** refer to the lamps listed on pages 5.34 to 5.39

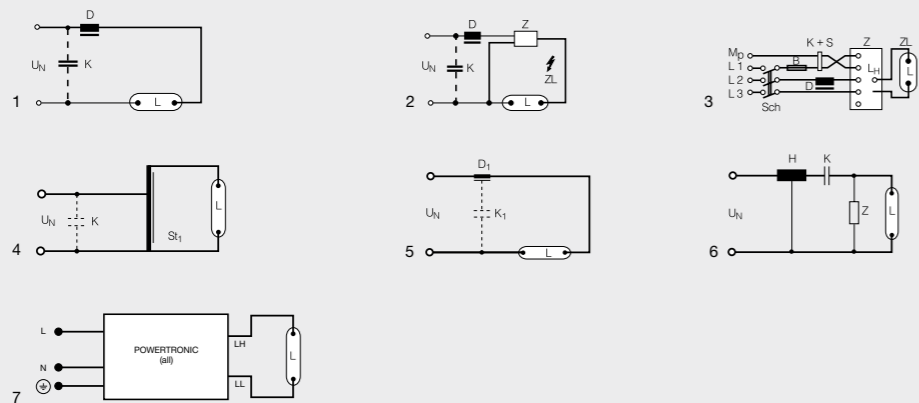

- B = 6 A fuse, slow acting
  - D = Choke
  - D<sub>1</sub> = Tapped choke
  - K = PFC capacitor
  - K<sub>1</sub> = PFC and ignition capacitor 5 μF
  - K+S = Time-limiting switch and contactor
  - L = Lamp
  - L<sub>H</sub> = High-voltage terminal
  - Mp = Neutral conductor
  - H = Hybrid control gear
  - Sch = Switch
  - St = High-reactance transformer
  - U<sub>N</sub> = 230 V ac line voltage (for 2000 W and 3500 W = 400 V ac)
  - Z = Igniter to be installed near the lamp
  - ZL = HF igniter lead to contact plate of lamp
- For single phase supplies the choke must be connected to the live lead.
- For reliable ignition the igniter approved for the lamp type must be used. For POWERTRONIC® electronic control gear for HCL®, HQL® and NAV® high-intensity lamps see Section 9.
- Chokes, lampholders, capacitors, high-reactance transformers and igniters are available from electrical suppliers.

### Luminous intensity distribution of reflector lamps

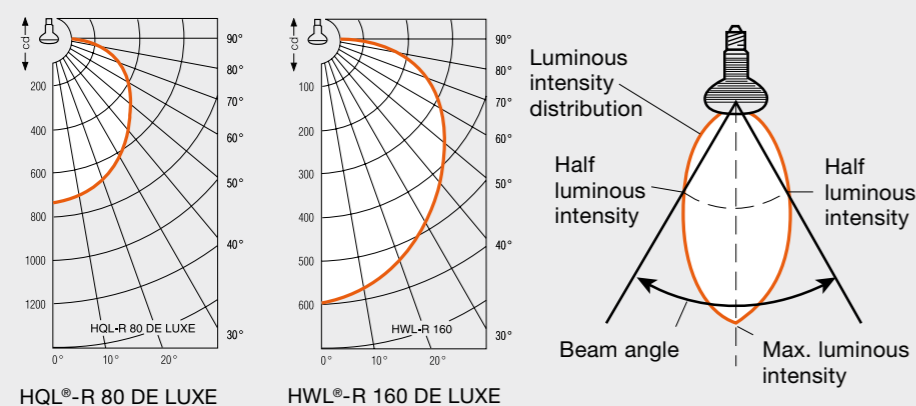

Lamp reference	Beam angle	Maximum illuminance (lux) at a distance from the lamp of		
		1,5 m	2,5 m	3,5 m
HQL-R 80 DE LUXE	120°	330	120	60
HWL-R 160 DE LUXE	120°	265	95	50

## Light colors and color rendering to DIN 5035

### Burning positions

### Bases

Light colors		Light color above 5000 K	Light color around 4000 K	Light color below 3400 K
Group 1 very good	1 A	POWERSTAR® HQL®/D	POWERBALL® HCL®/942/NDL	POWERBALL® HCL®/930/WDL
	1 B		POWERSTAR® HQL®/NDL	POWERBALL® HCL®/830/WDL
	R <sub>a</sub> 80-89		POWERSTAR® HQL®/WDL	
Group 2 good	2 A			
	R <sub>a</sub> 70-79			
	2 B		POWERSTAR® HQL®/N HWL®	HQL® SUPER DE LUXE
Group 3 acceptable	R <sub>a</sub> 40-59		HQL®	HQL® DE LUXE
	R <sub>a</sub> 20-39			VIALOX® NAV® VIALOX® NAV® 4Y® VIALOX® NAV® SUPER 4Y®

For details of color temperature see page 5.34 to 5.39

### Burning positions

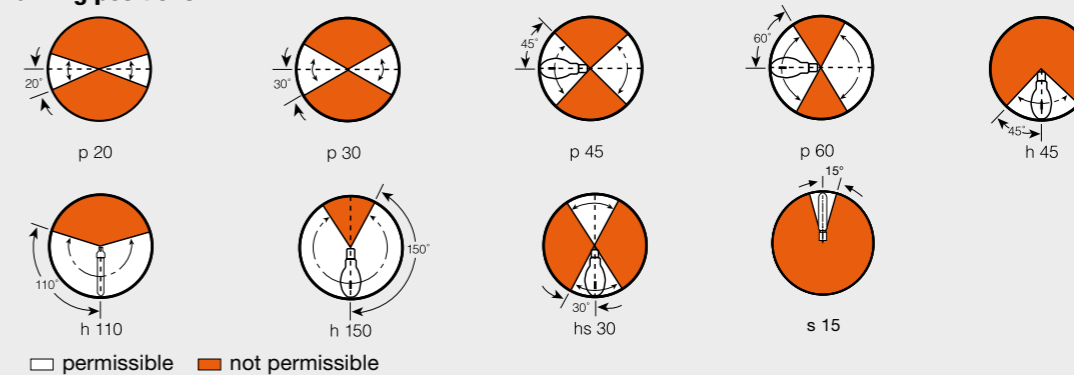

### Bases

